

Applicable Model

R29C-L

Drawing Title

Intercom Panel

Drawing Unit

mm

Drawing Scale

Not to scale

**DRAFT
SUBJECT TO
CHANGE**

Last Revised

Mar 31,2021

Drawing Version

V1.0

Page

1 of 9

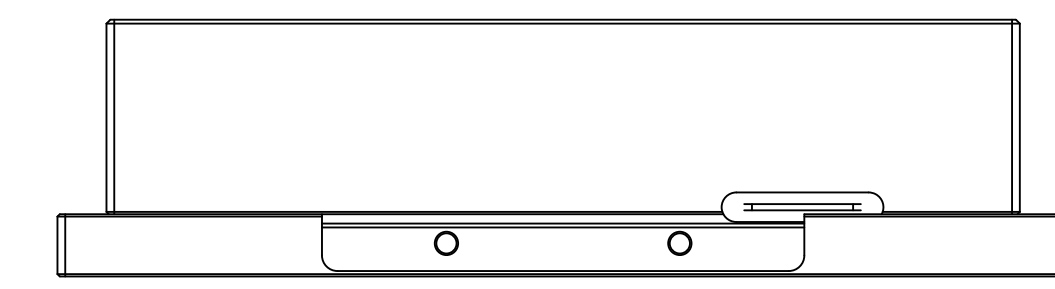

5 TOP VIEW

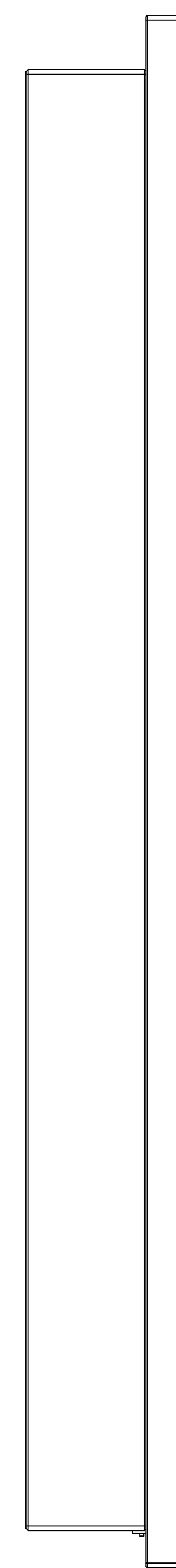

2 RIGHT VIEW

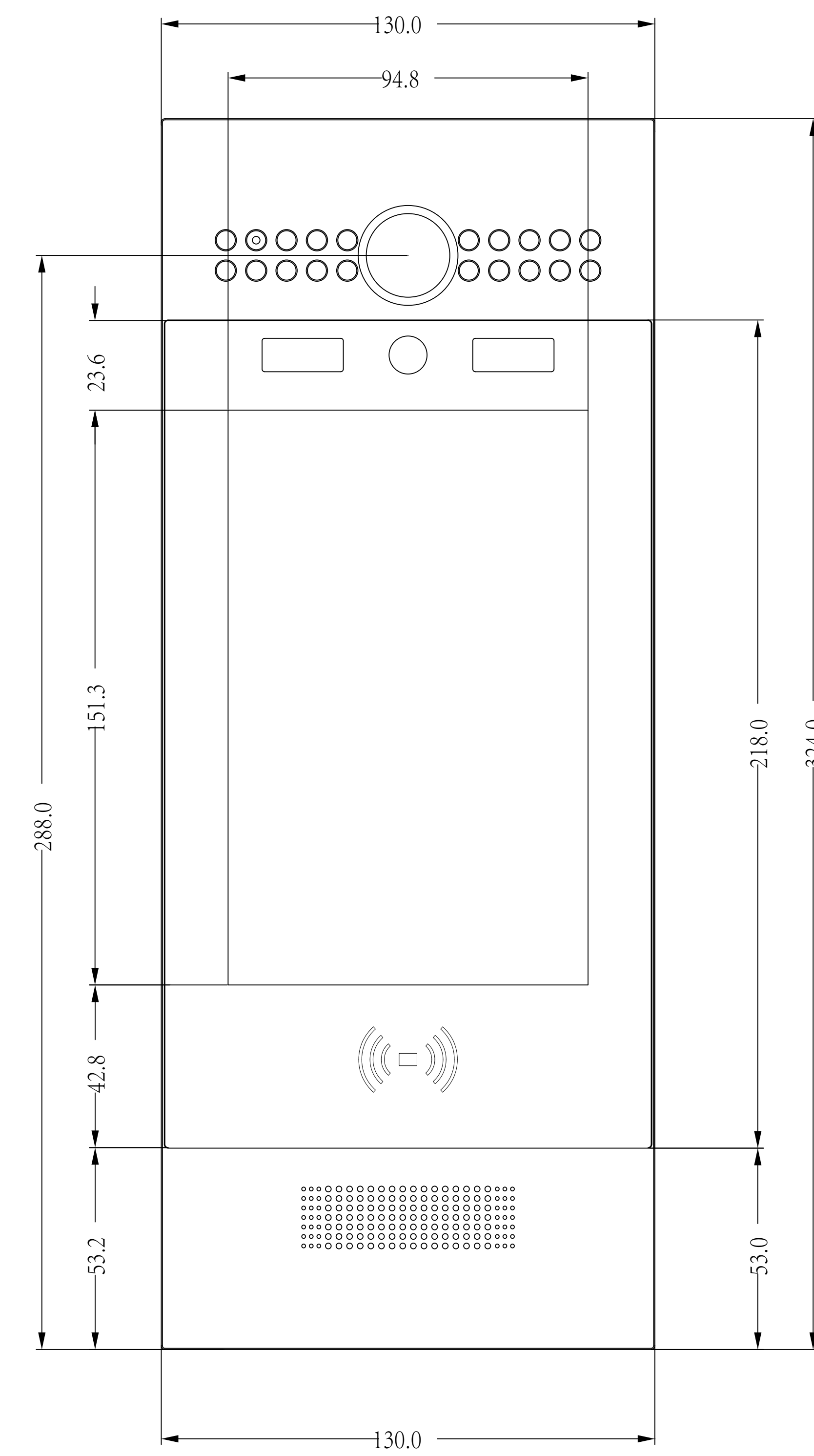

1 FRONT VIEW

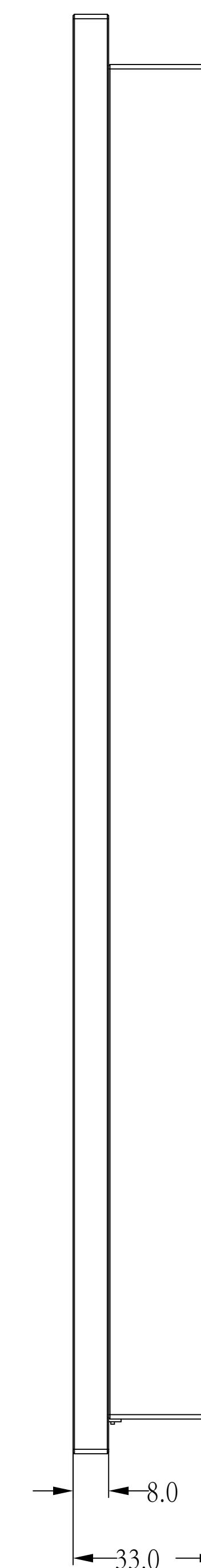

3 LEFT VIEW

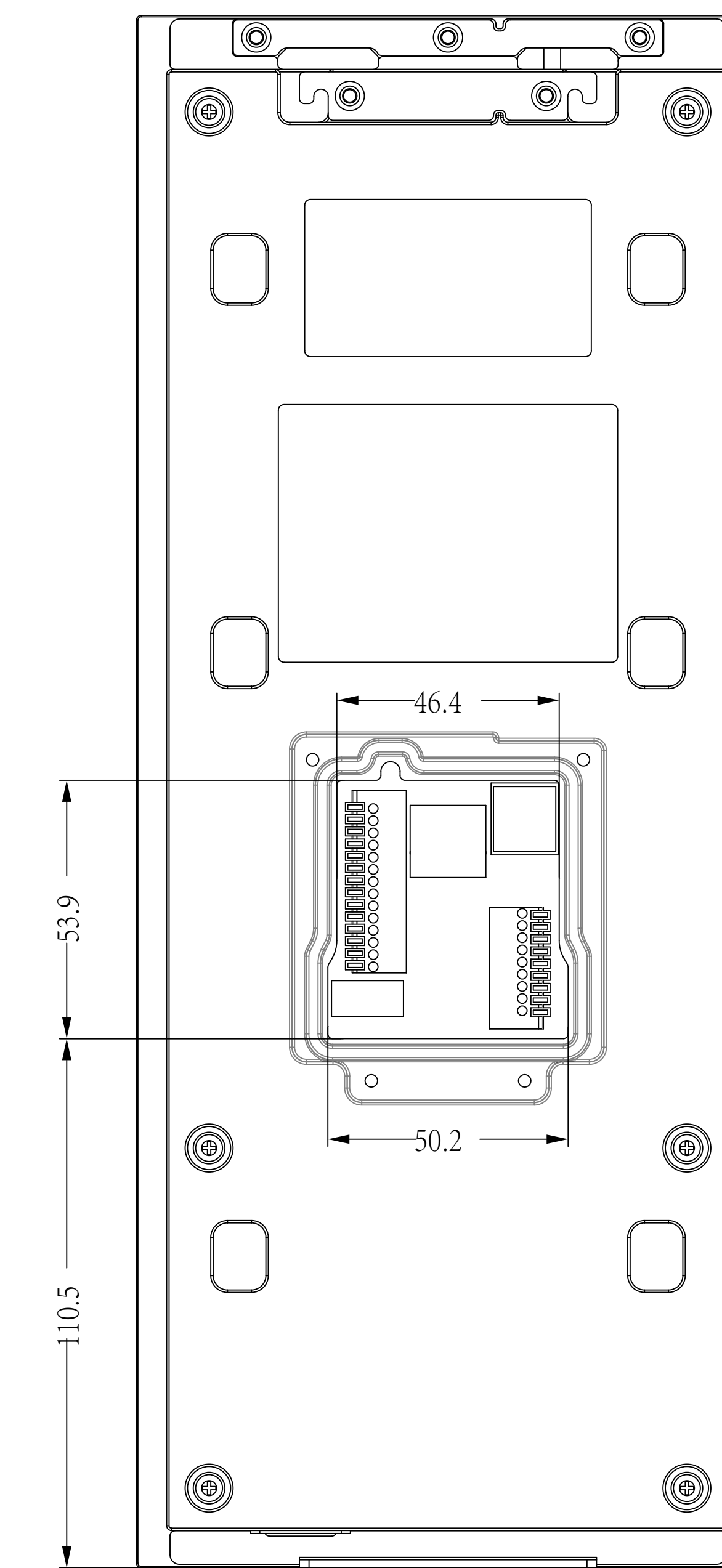

4 BACK VIEW

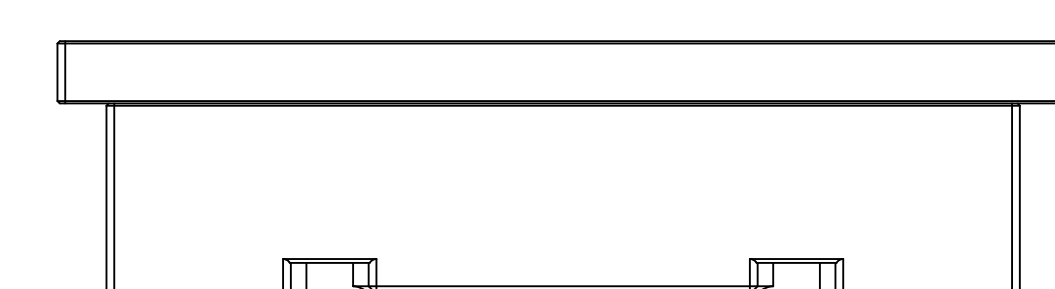

6 BOTTOM VIEW

Applicable Model

R29C-L

Drawing Title

Wall Mounting Bracket

Drawing Unit

mm

Drawing Scale

Not to scale

**DRAFT
SUBJECT TO
CHANGE**

Last Revised

Mar 31,2021

Drawing Version

V1.0

Page

2 of 9

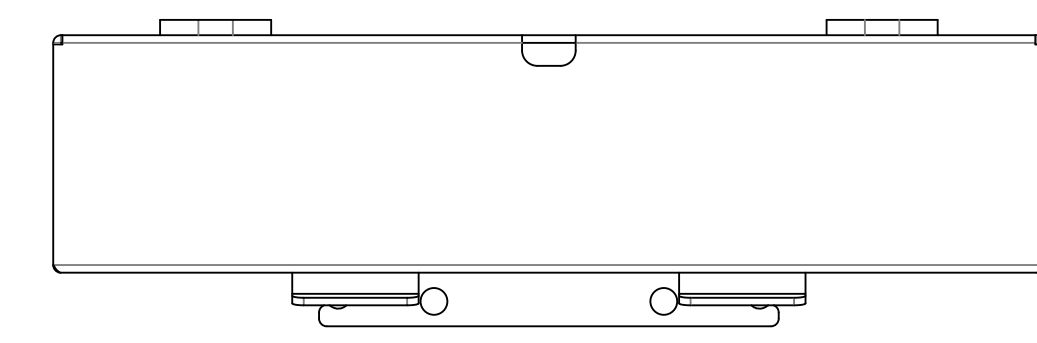

5 TOP VIEW

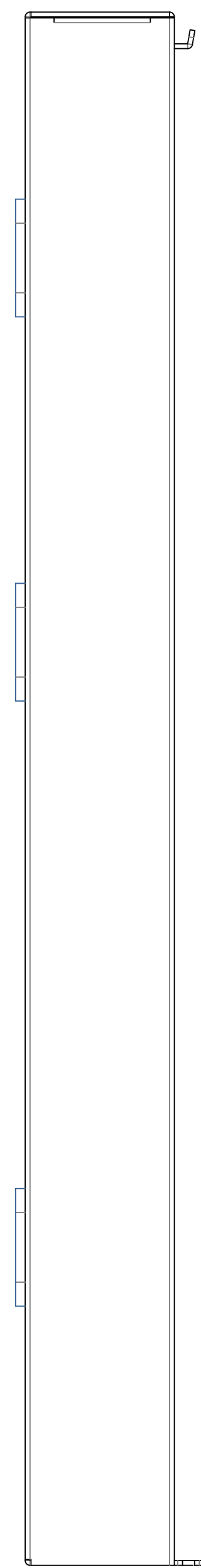

2 RIGHT VIEW

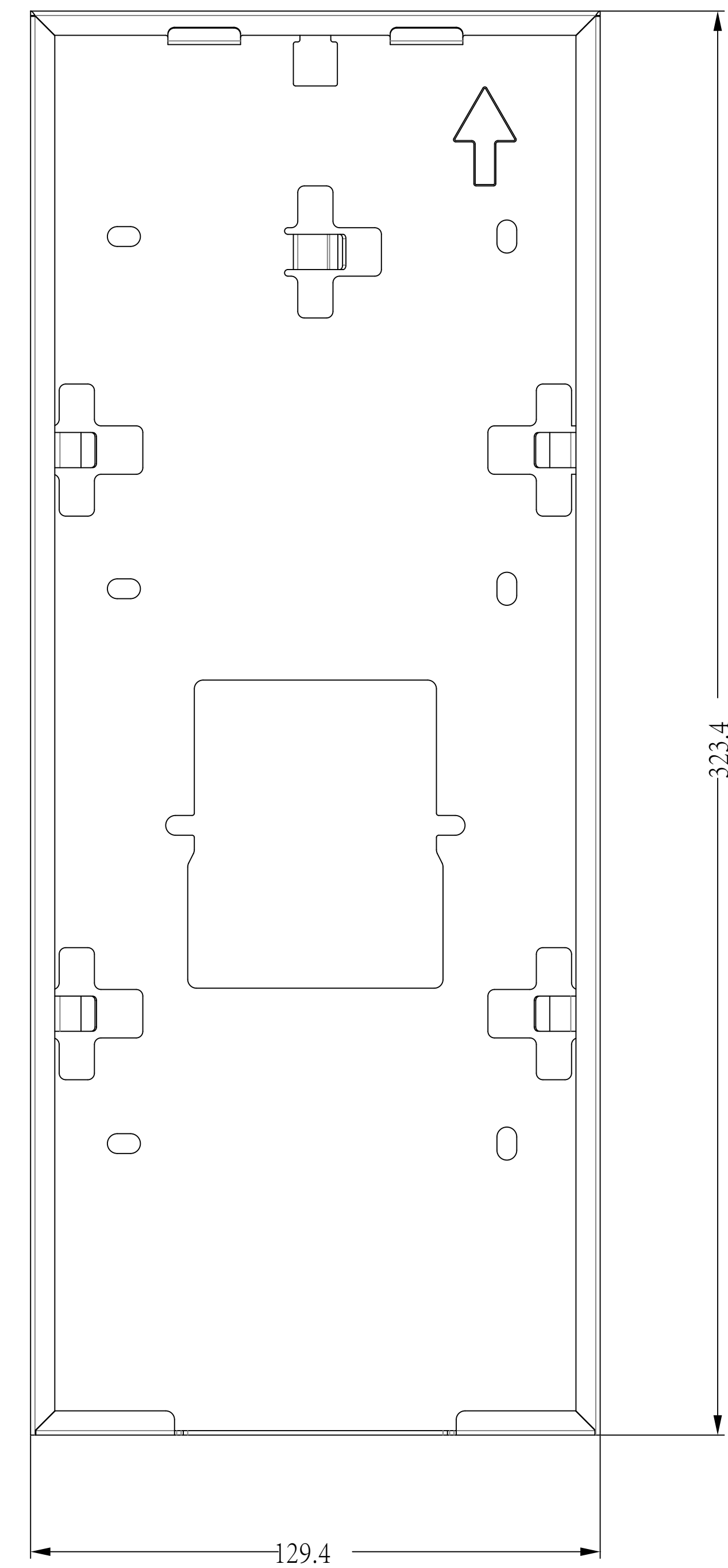

1 FRONT VIEW

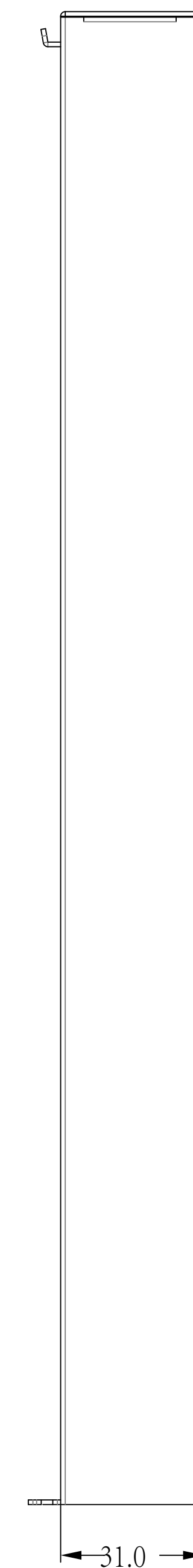

3 LEFT VIEW

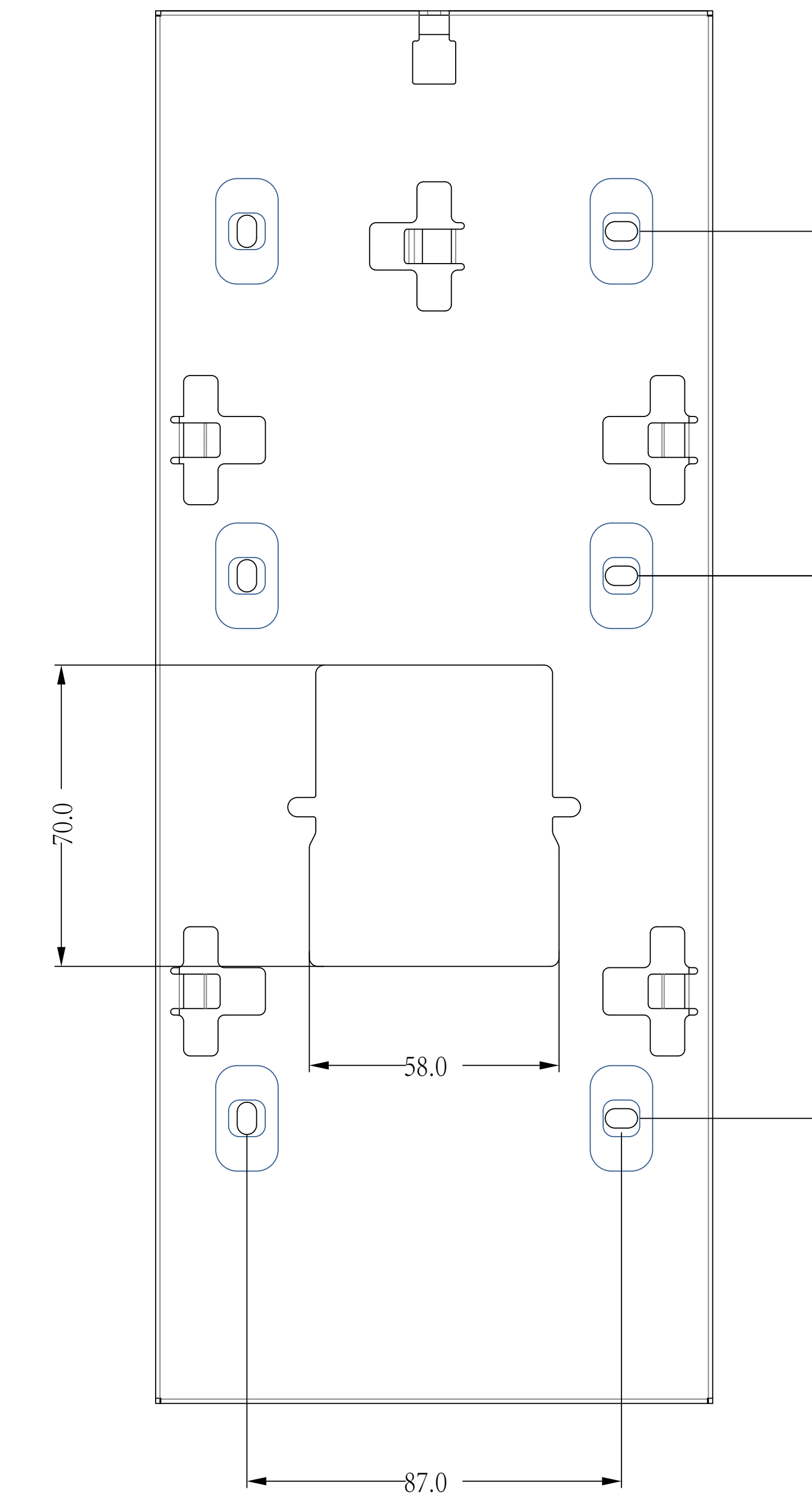

4 BACK VIEW

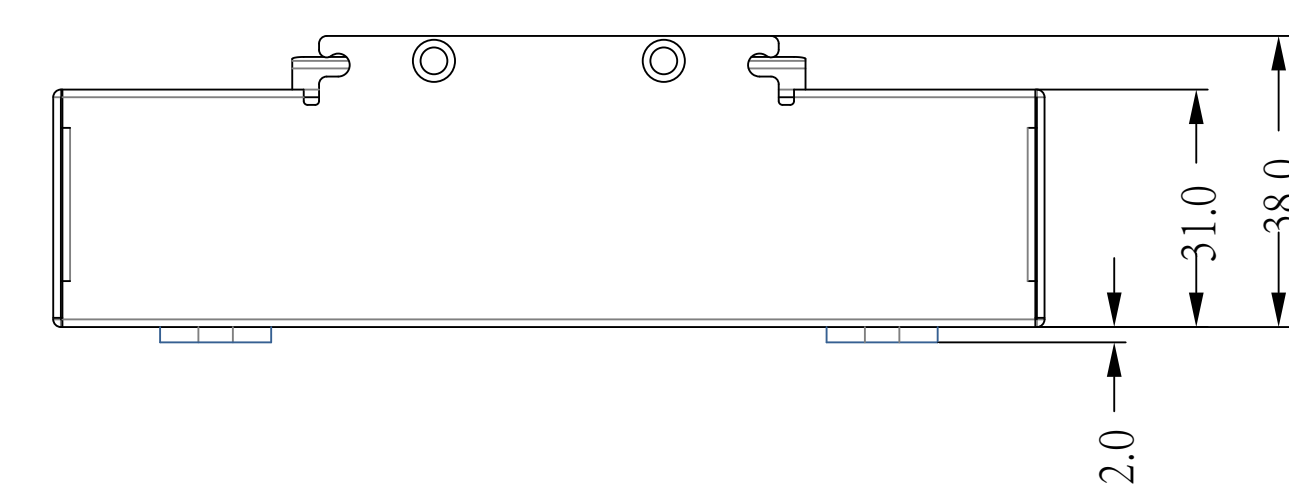

6 BOTTOM VIEW

Applicable Model
R29C-L

Drawing Title
Placement

Drawing Unit
mm

Drawing Scale
Not to scale

DRAFT
SUBJECT TO
CHANGE

Last Revised
Mar 31,2021

Drawing Version
V1.0

Page
3 of 9

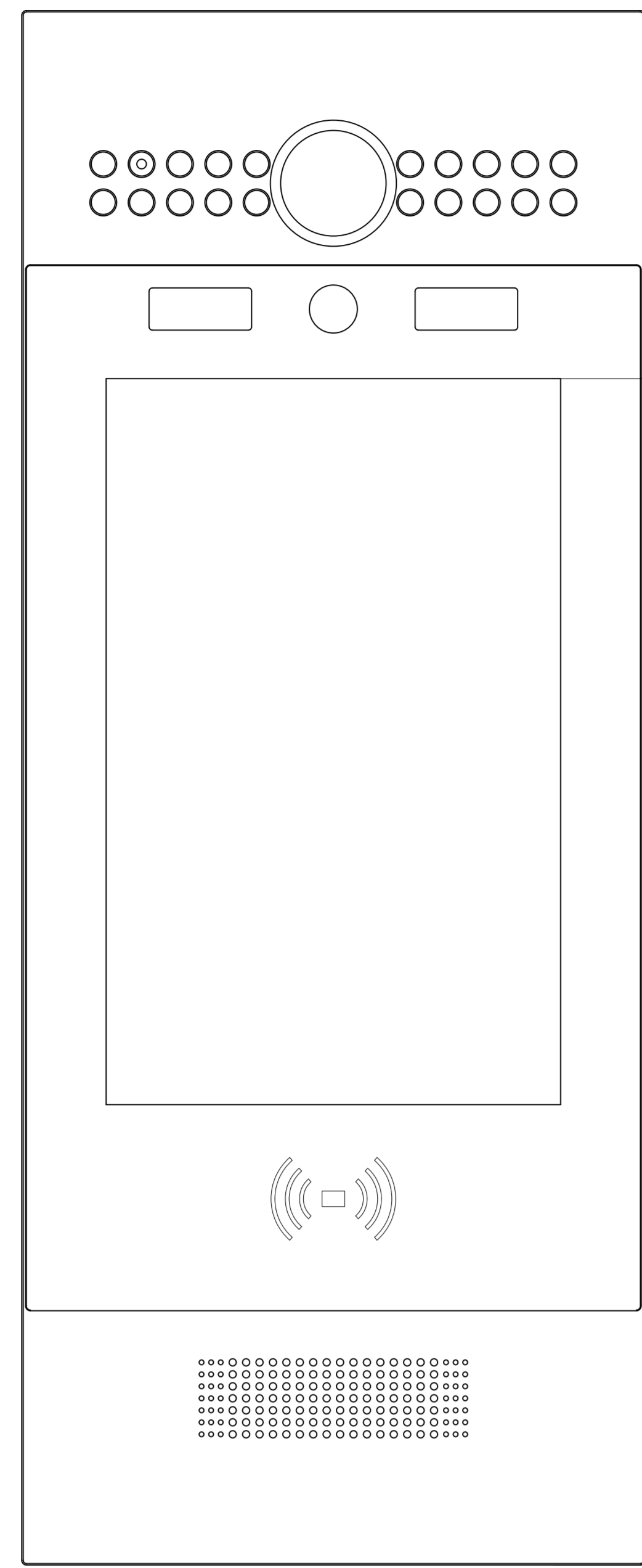

① INTERCOM PANEL FRONT VIEW

973mm TO BOTTOM OF PANEL

1220mm MAX TO TOP OF USABLE TOUCHSCREEN

ADA Compliance Requirement

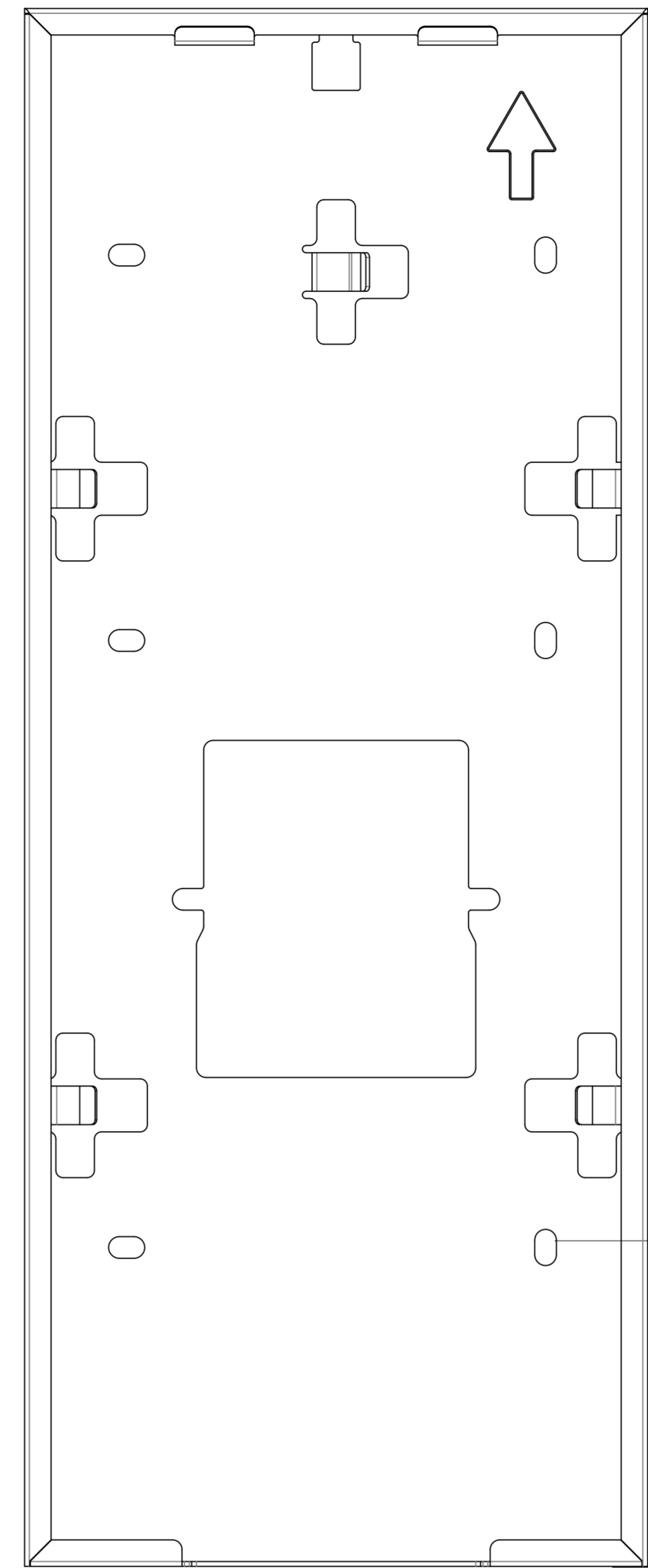
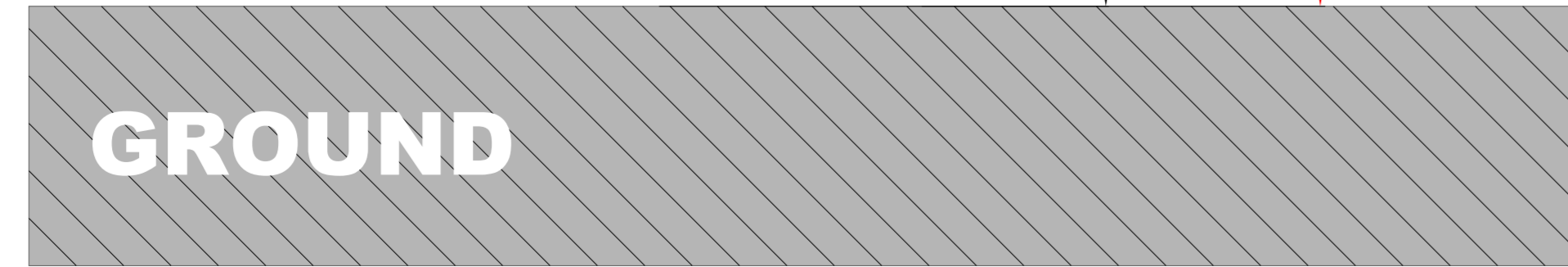

② FRONT VIEW:WALL MOUNTING BRACKET PLACEMENT

973mm TO BOTTOM OF BRACKET

1039mm TO SCREW HOLE CENTER OF BRACKET

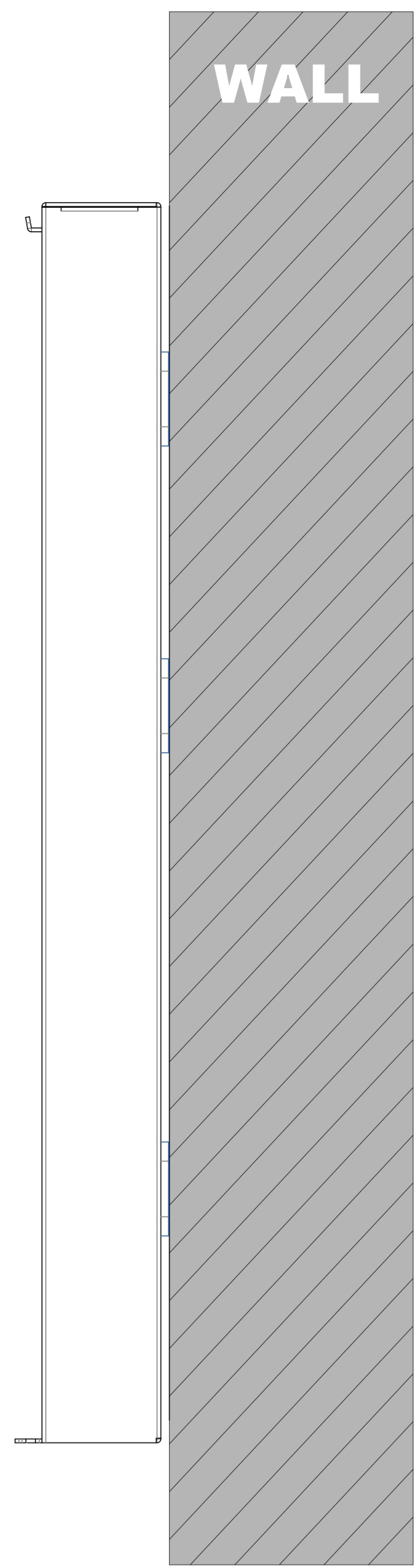
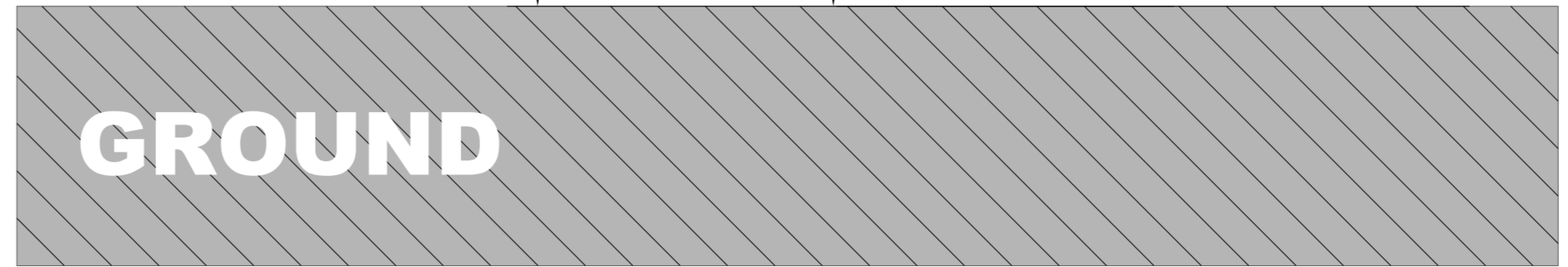

③ SIDE VIEW:INTERCOM ON WALL

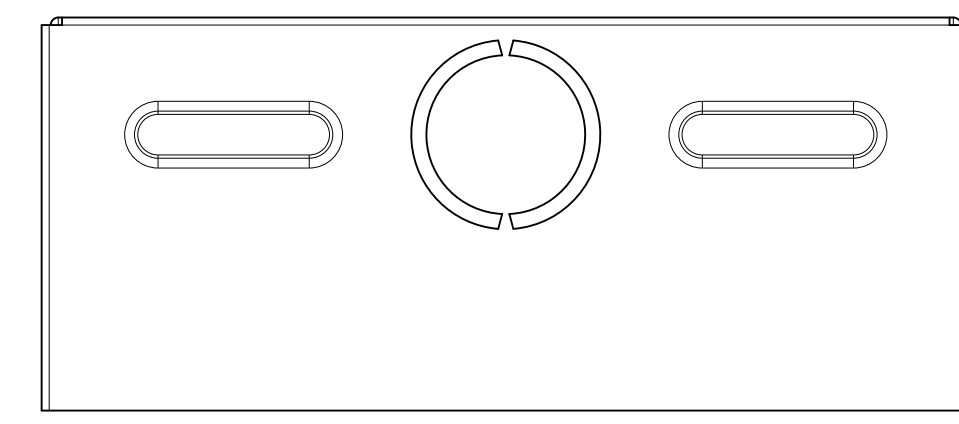

5 **TOP VIEW**

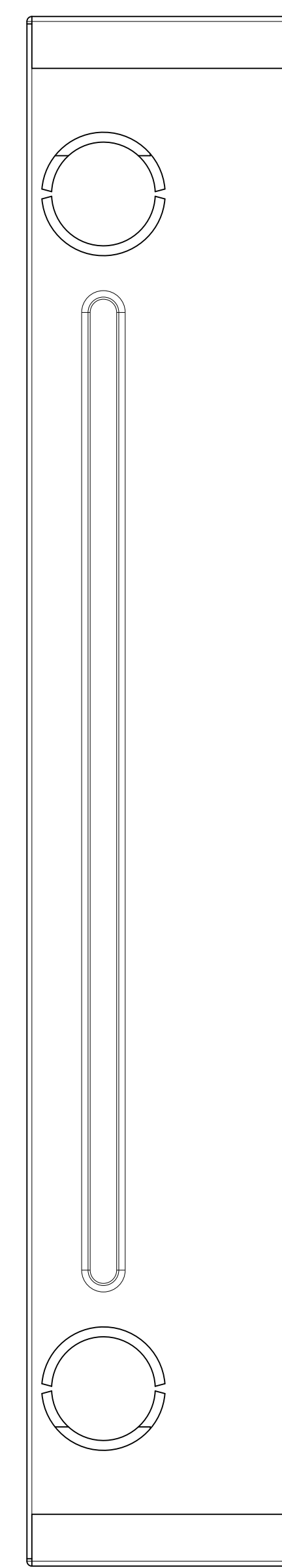

2 **RIGHT VIEW**

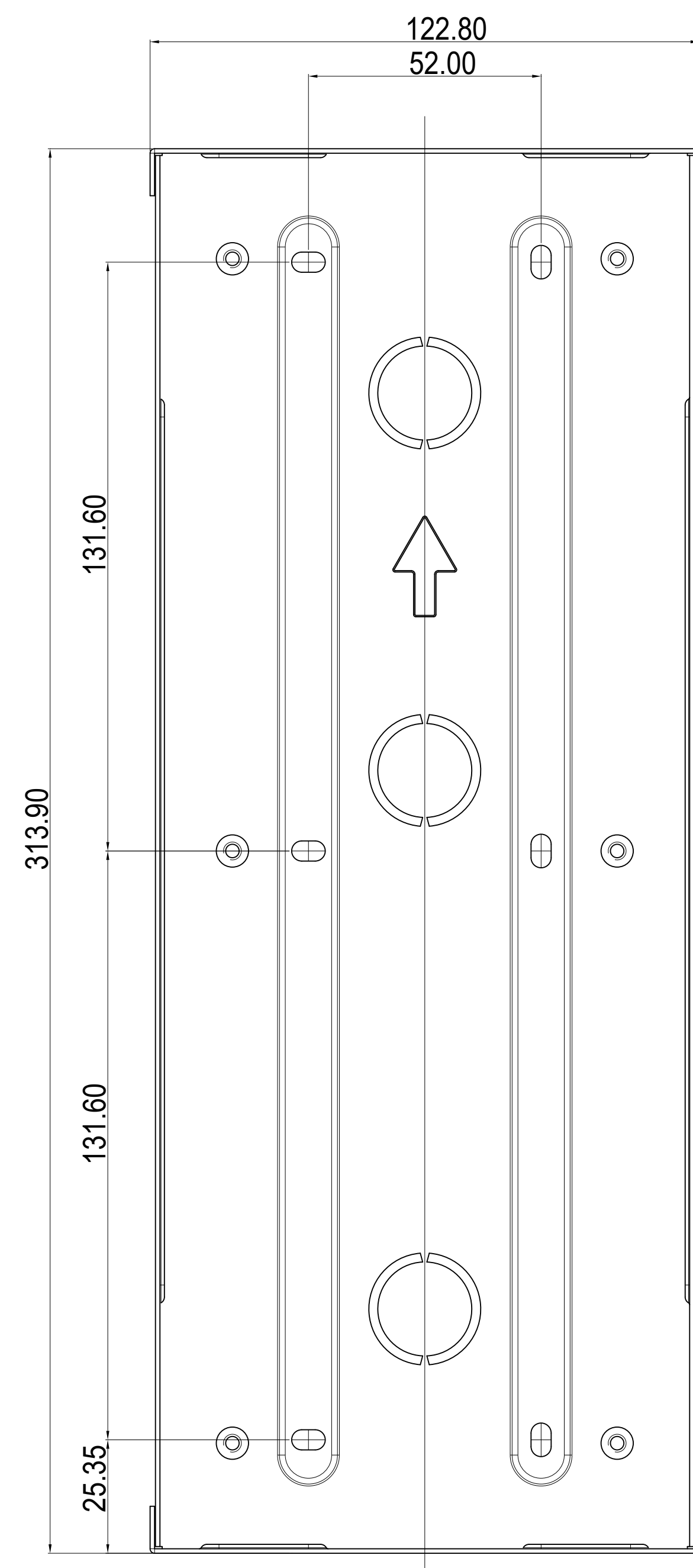

1 **FRONT VIEW**

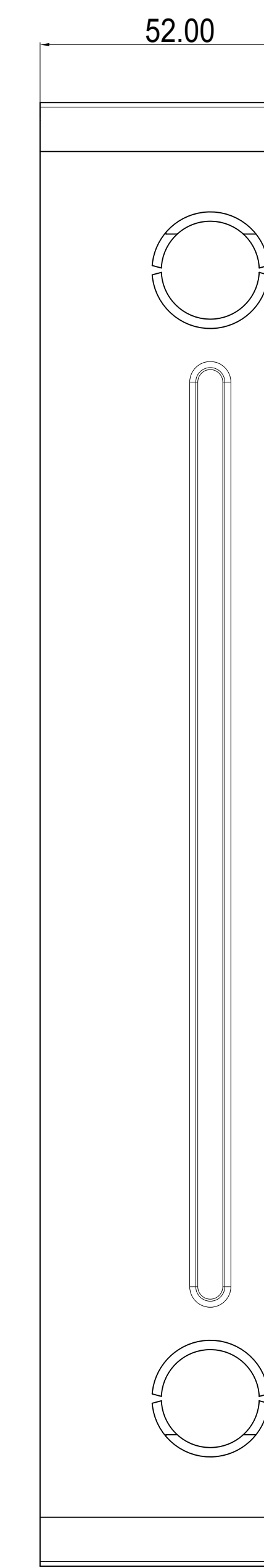

3 **LEFT VIEW**

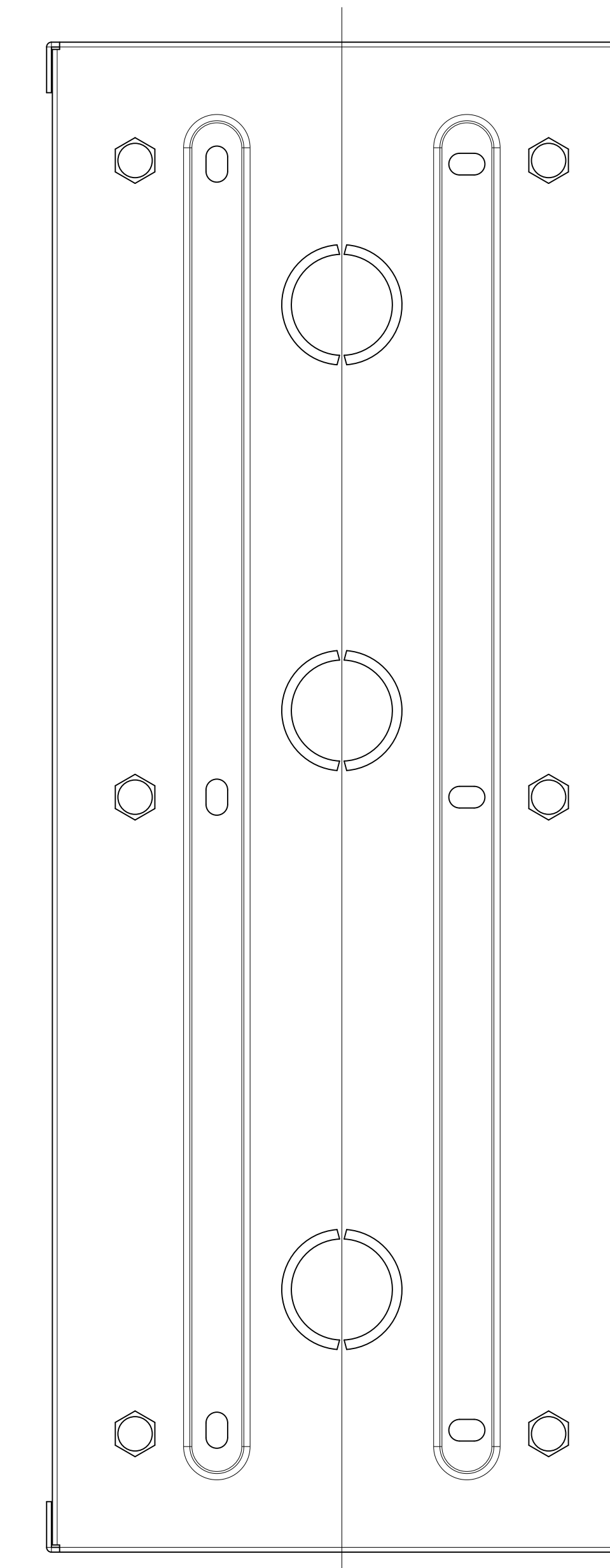

4 **BACK VIEW**

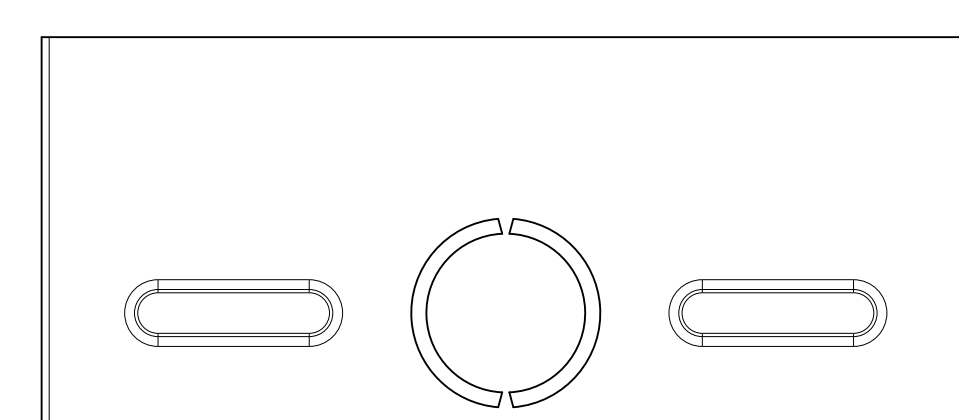

6 **BOTTOM VIEW**

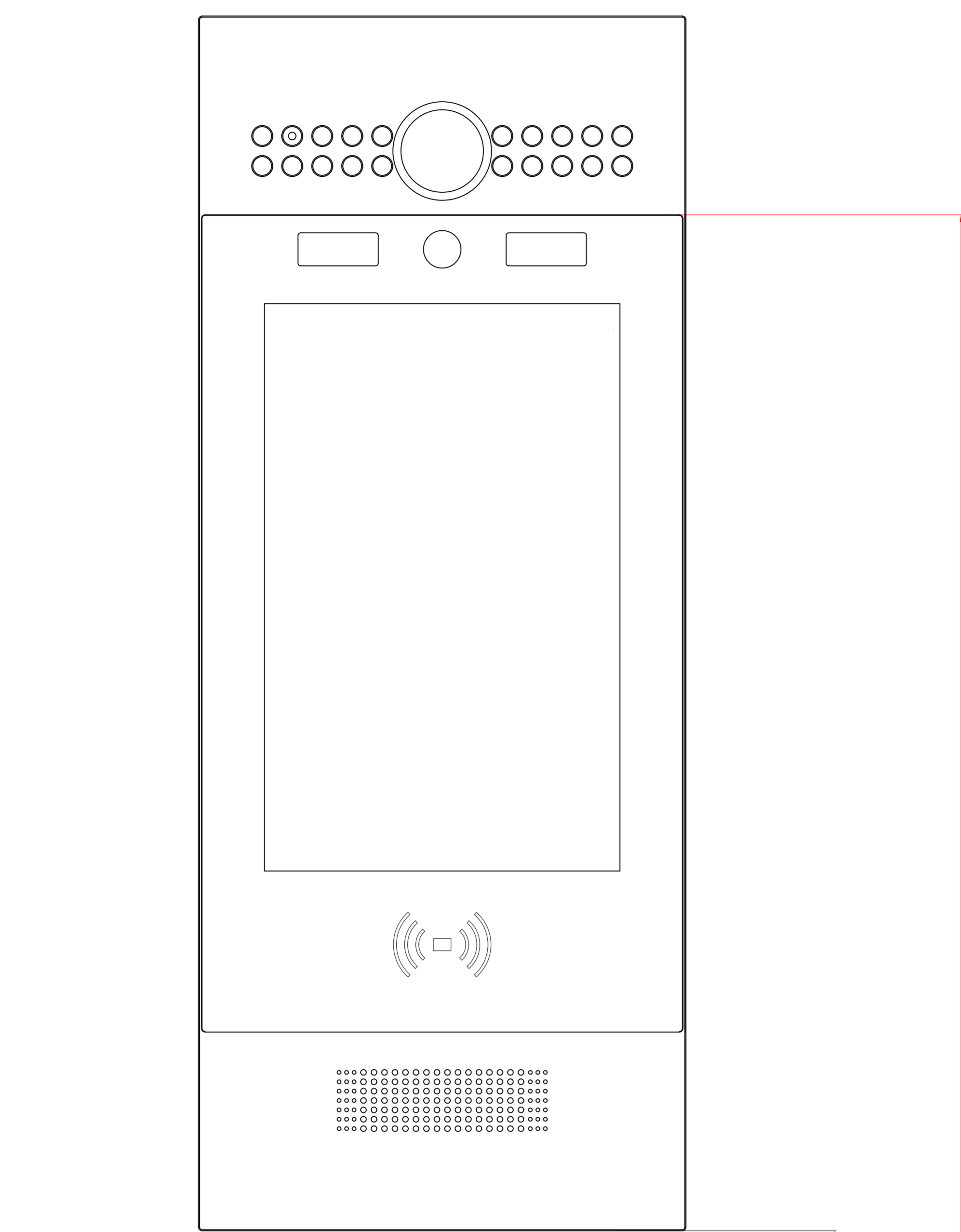

973mm TO BOTTOM OF PANEL

1220mm MAX TO TOP OF USABLE TOUCHSCREEN

ADA Compliance Requirement

GROUND

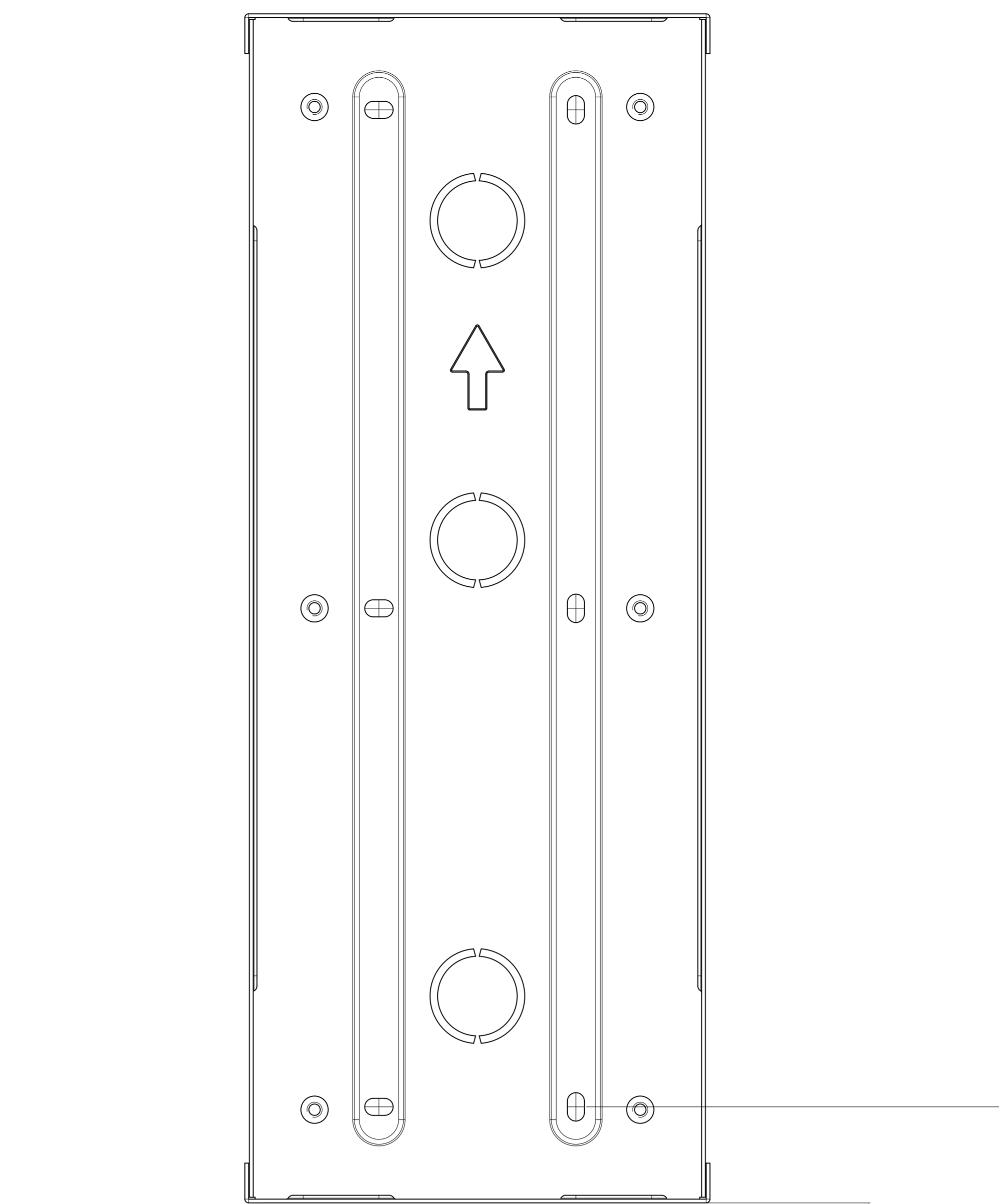

973 mm TO BOTTOM OF BRACKET

998mm TO SCREW HOLE CENTER OF BRACKET

GROUND

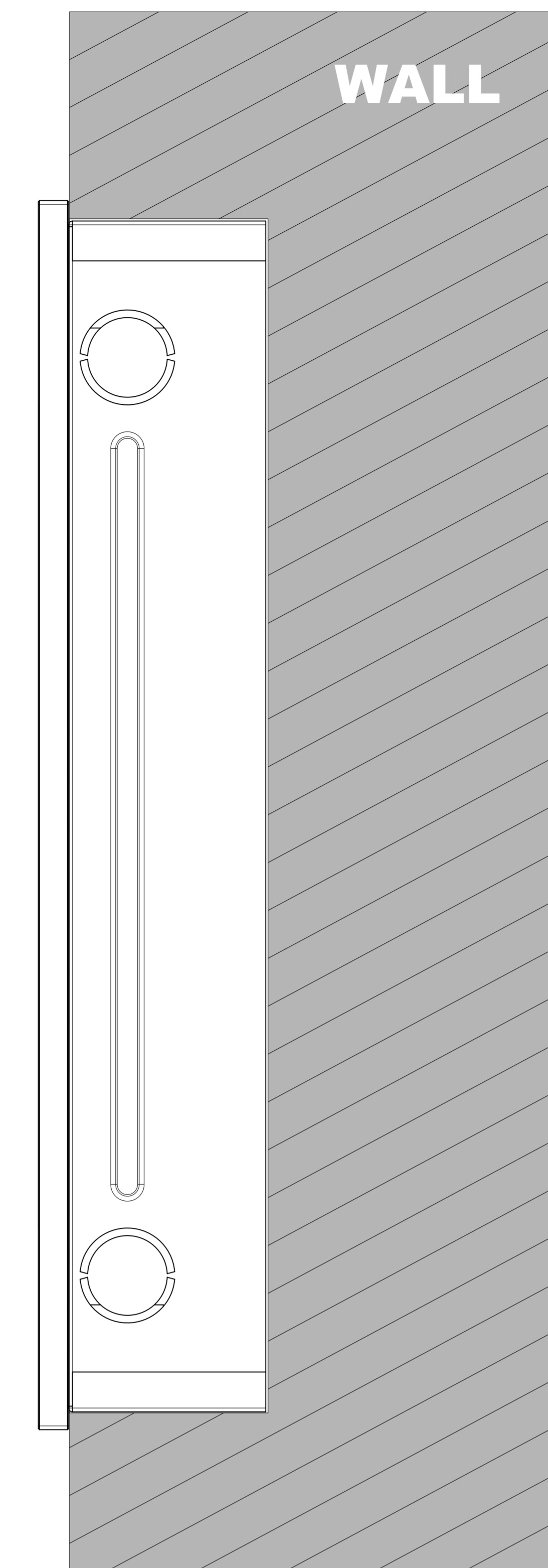

WALL

Applicable Model

R29C-L

Drawing Title

On-Wall Mounting
Rain Cover

Drawing Unit

mm

Drawing Scale

Not to scale

**DRAFT
SUBJECT TO
CHANGE**

Last Revised

Mar 31,2021

Drawing Version

V1.0

Page

6 of 9



⑤ **TOP VIEW**

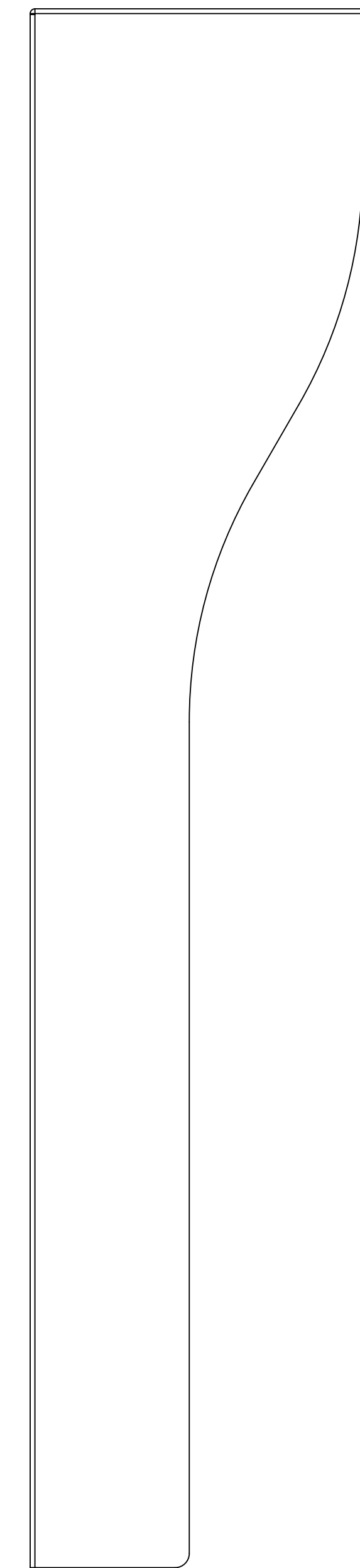

② **RIGHT VIEW**

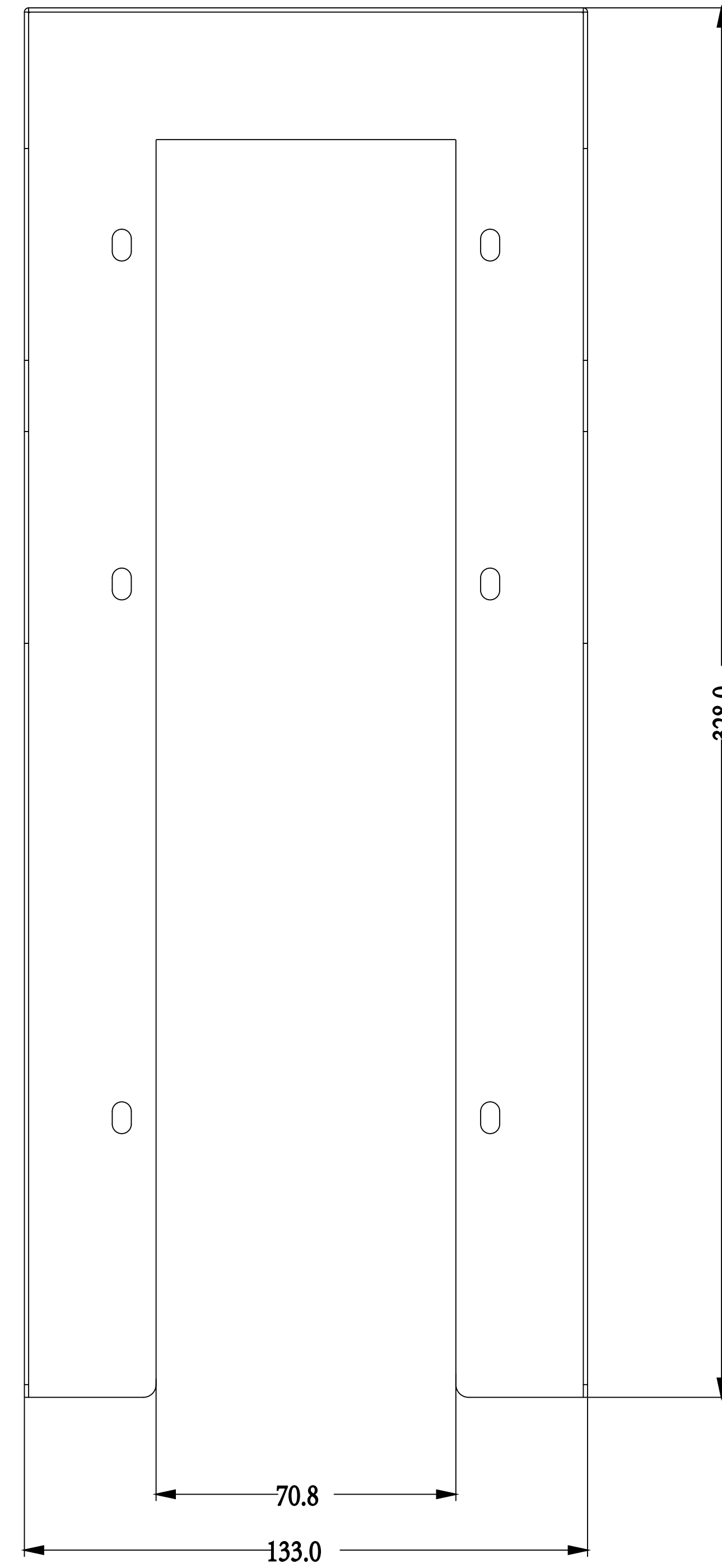

① **FRONT VIEW**

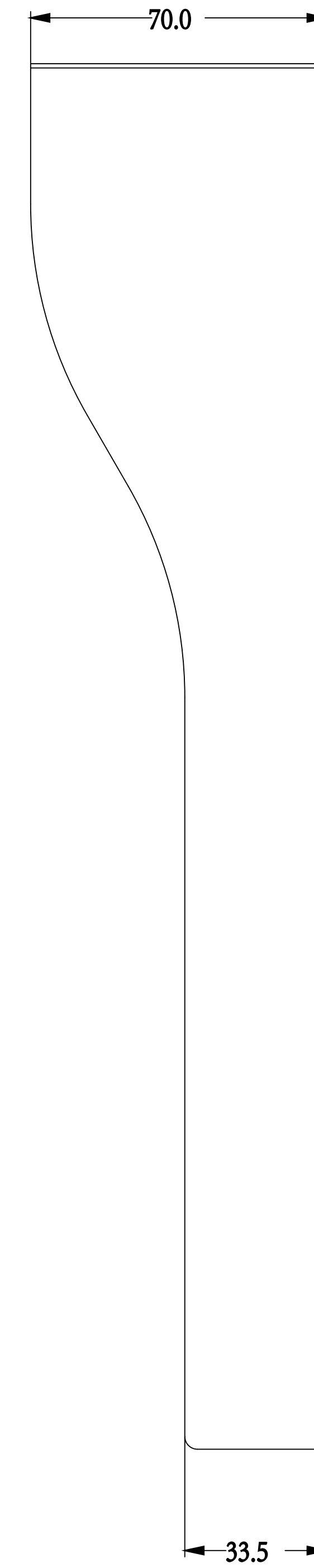

③ **LEFT VIEW**

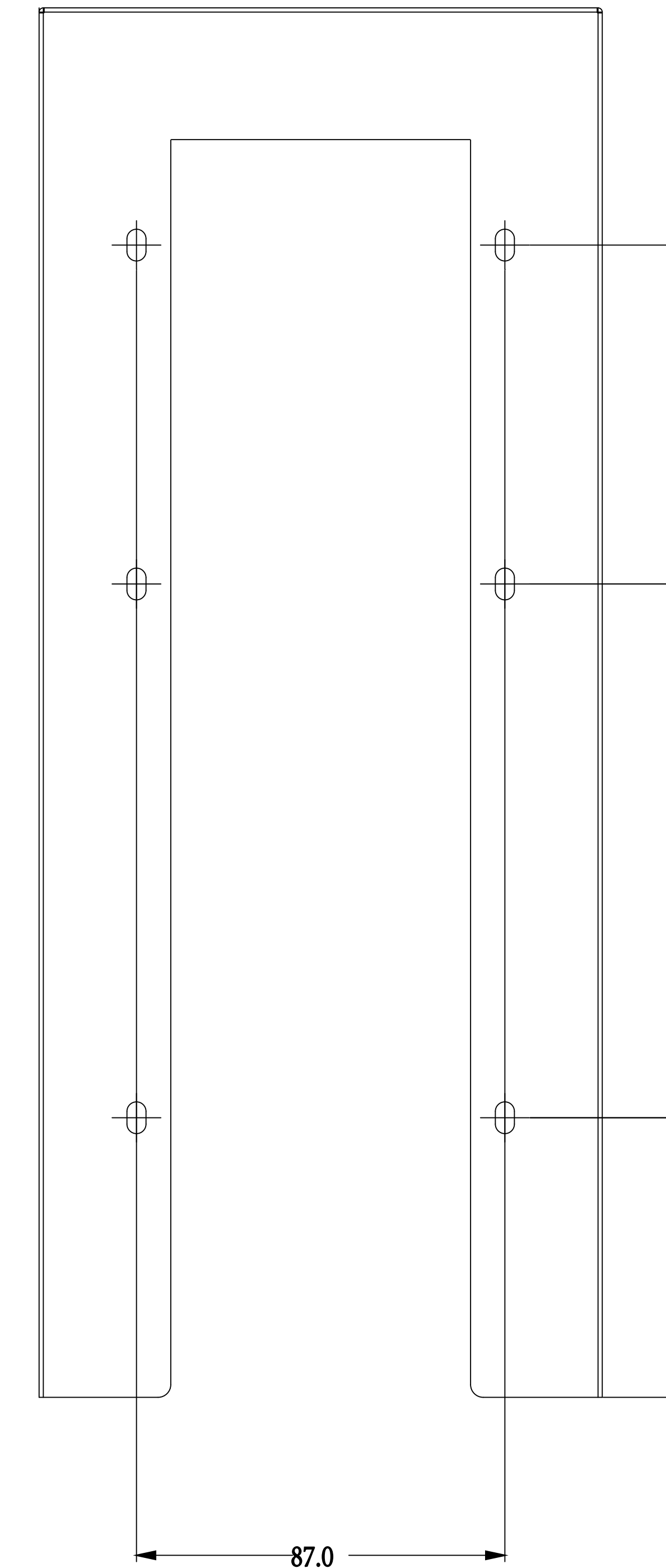

④ **BACK VIEW**



⑥ **BOTTOM VIEW**

Applicable Model

R29C-L

Drawing Title

Placement

Drawing Unit

mm

Drawing Scale

Not to scale

**DRAFT
SUBJECT TO
CHANGE**

Last Revised

Mar 31,2021

Drawing Version

V1.0

Page

7 of 9

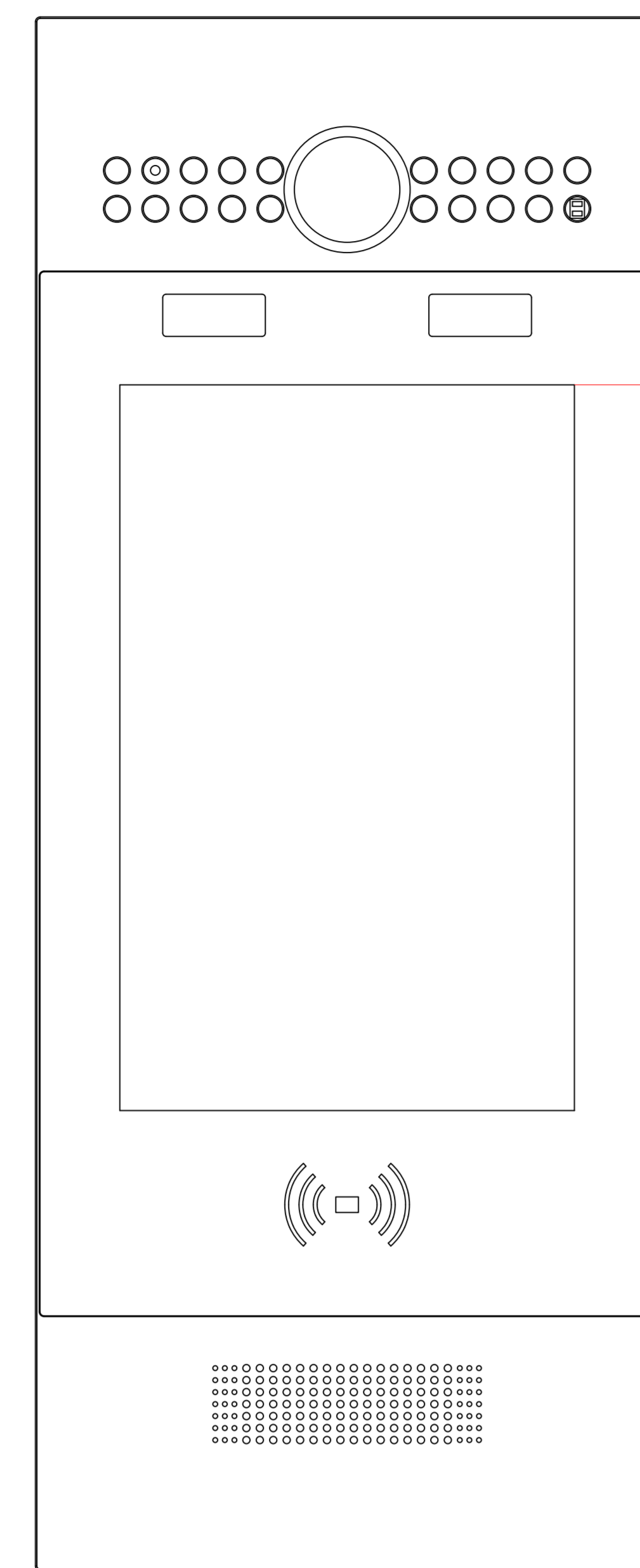

① INTERCOM PANEL FRONT VIEW

973mm TO BOTTOM OF PANEL

1220mm MAX TO TOP OF USABLE TOUCHSCREEN

ADA Compliance Requirement

GROUND

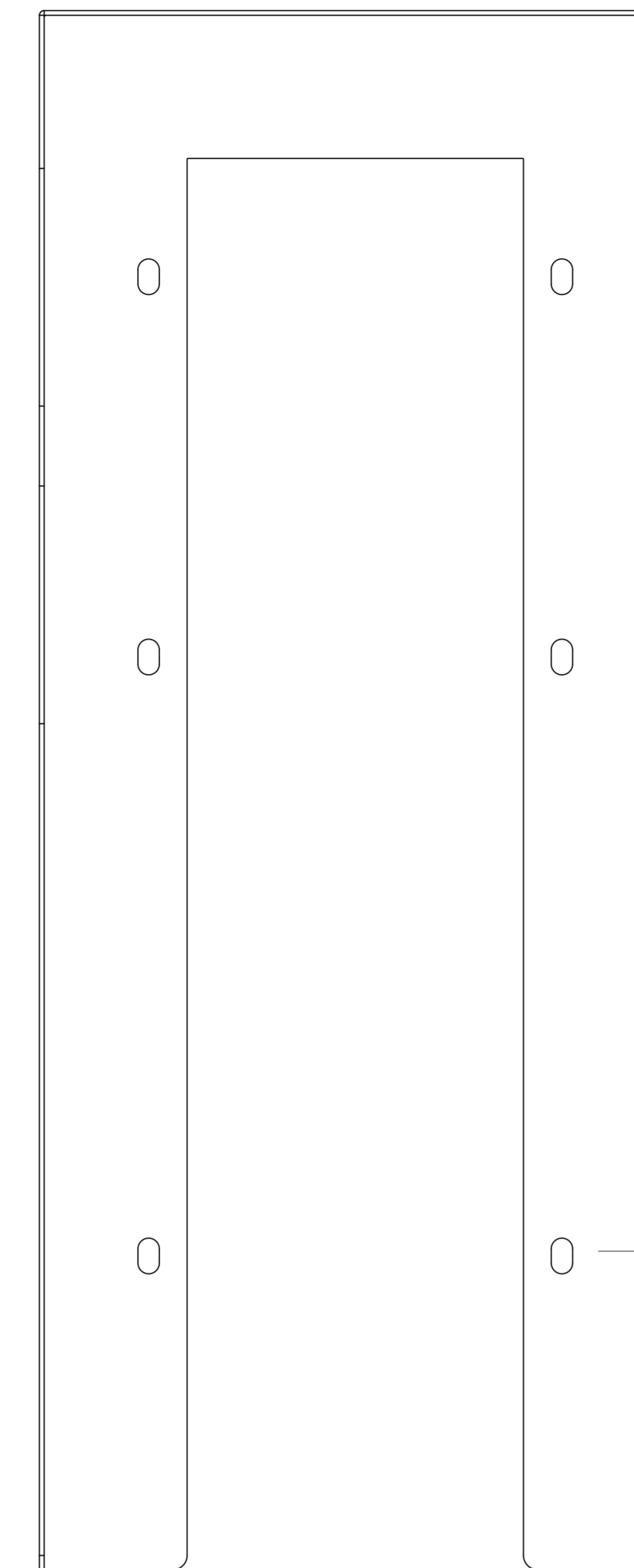

② FRONT VIEW: WALL MOUNTING RAIN COVER PLACEMENT

973 mm TO BOTTOM OF BRACKET

1039m TO SCREW HOLE CENTER OF BRACKET

GROUND

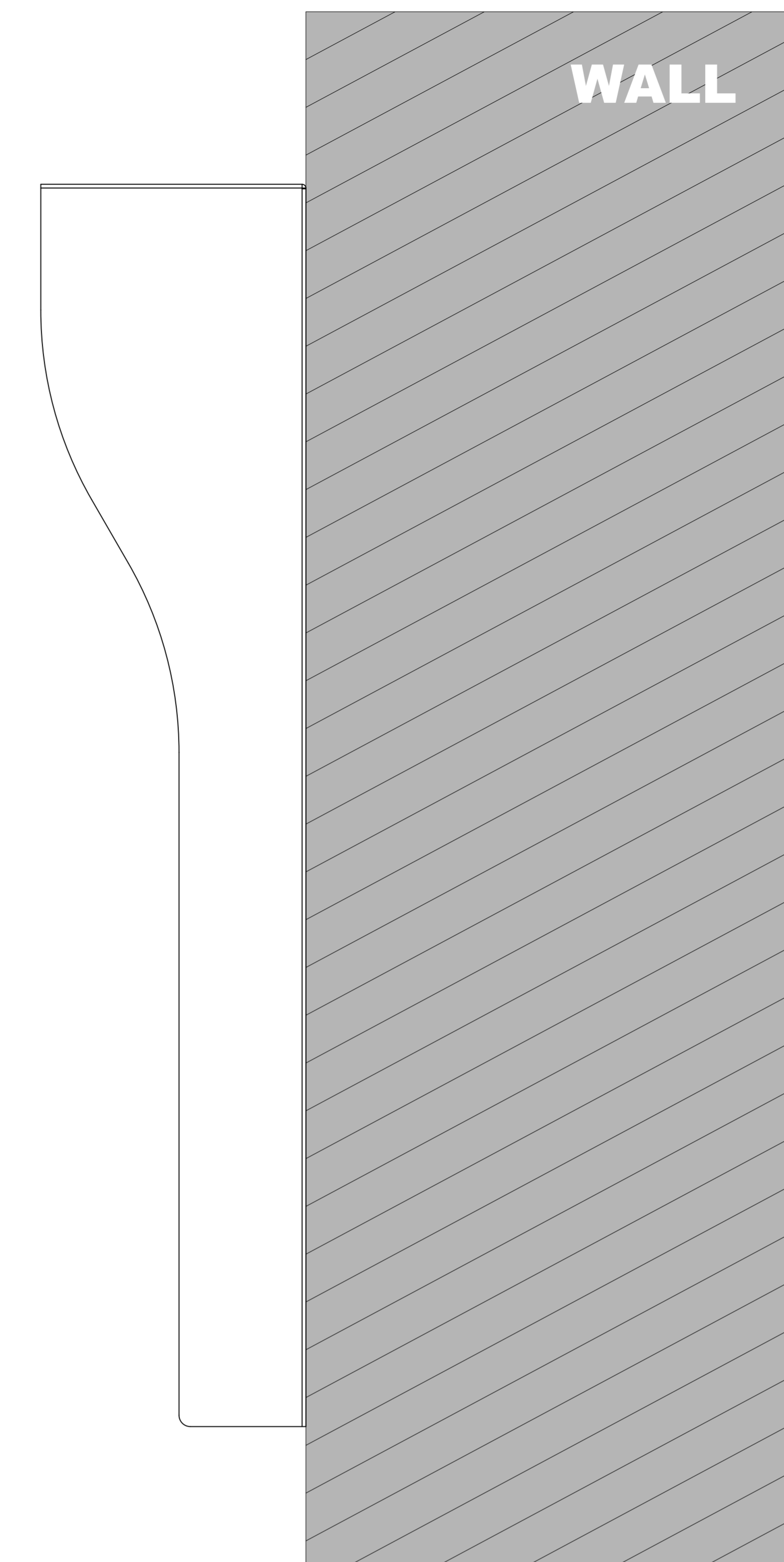

③ SIDE VIEW:INTERCOM ON WALL

Applicable Model

R29C-L

Drawing Title

In-Wall Mounting
Rain Cover

Drawing Unit

mm

Drawing Scale

Not to scale

**DRAFT
SUBJECT TO
CHANGE**

Last Revised

Mar 31,2021

Drawing Version

V1.0

Page

8 of 9



⑤ **TOP VIEW**

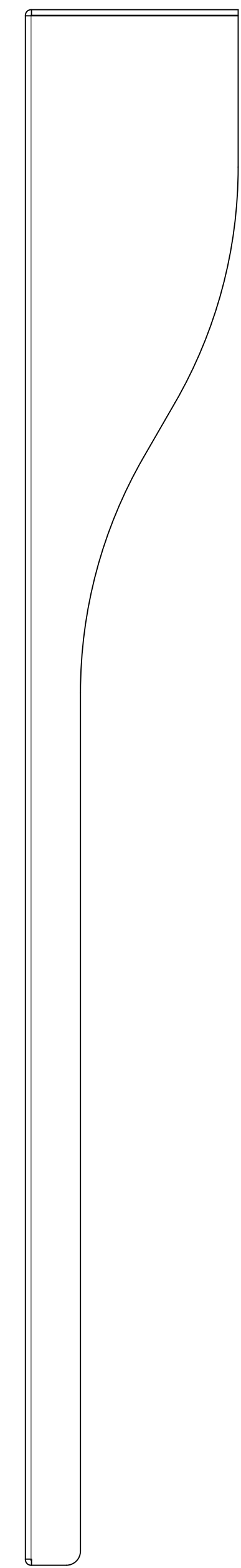

② **RIGHT VIEW**

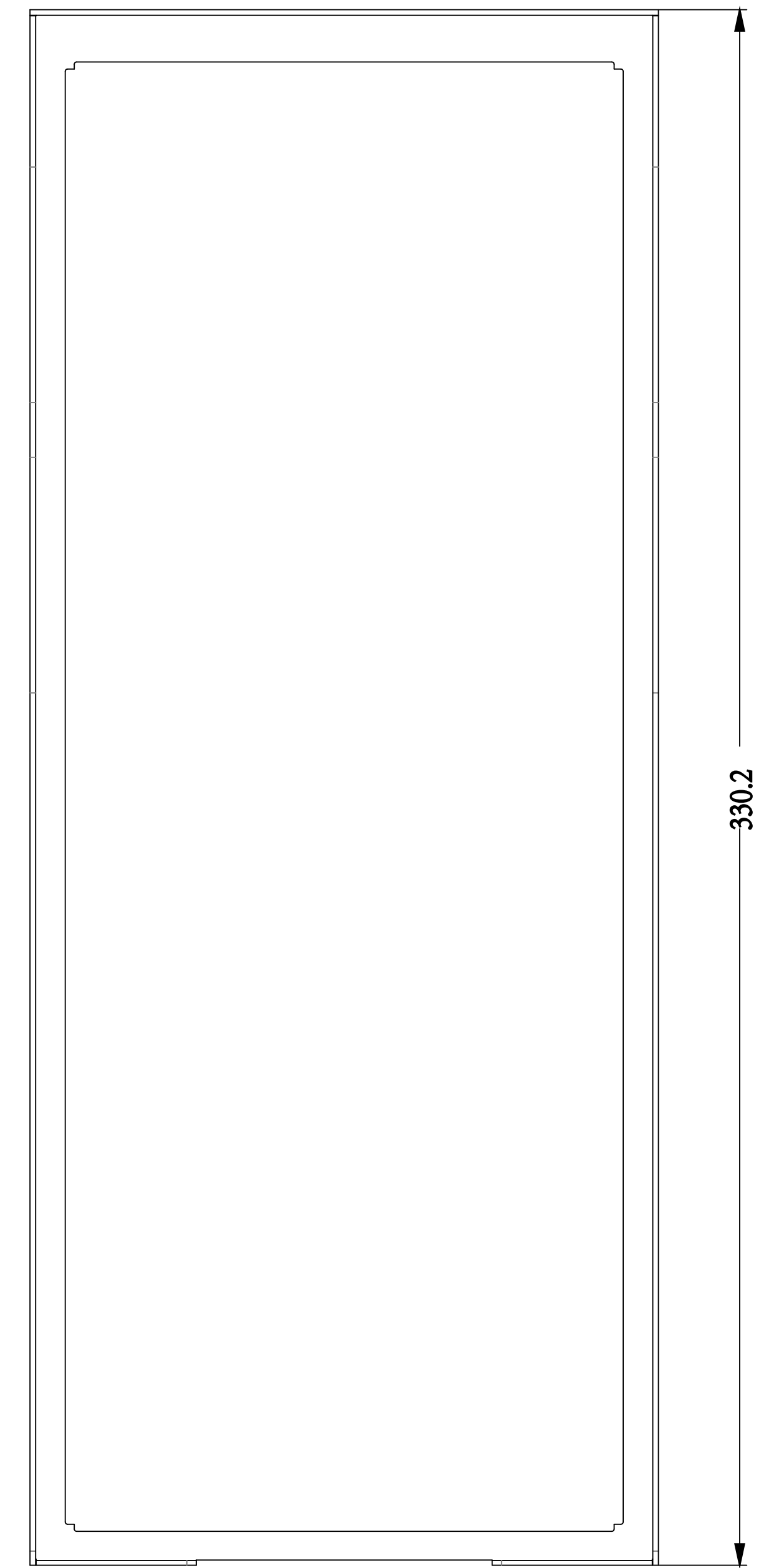

① **FRONT VIEW**

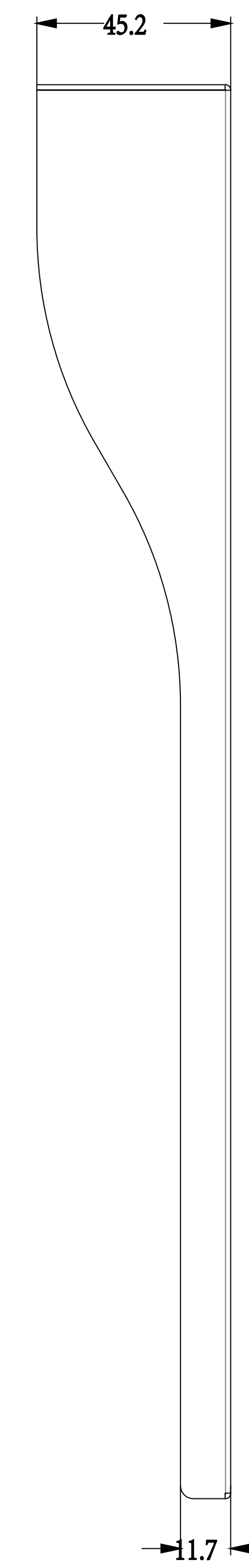

③ **LEFT VIEW**

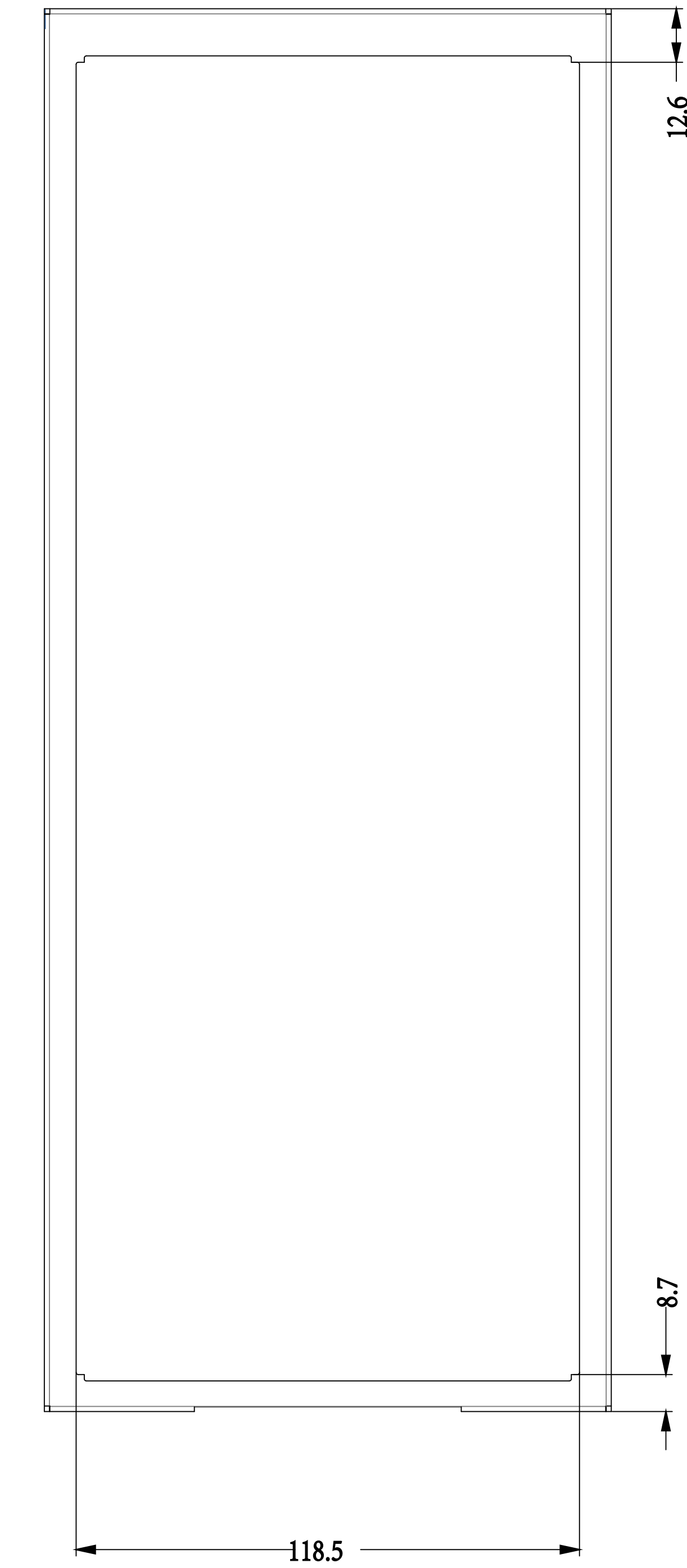

④ **BACK VIEW**

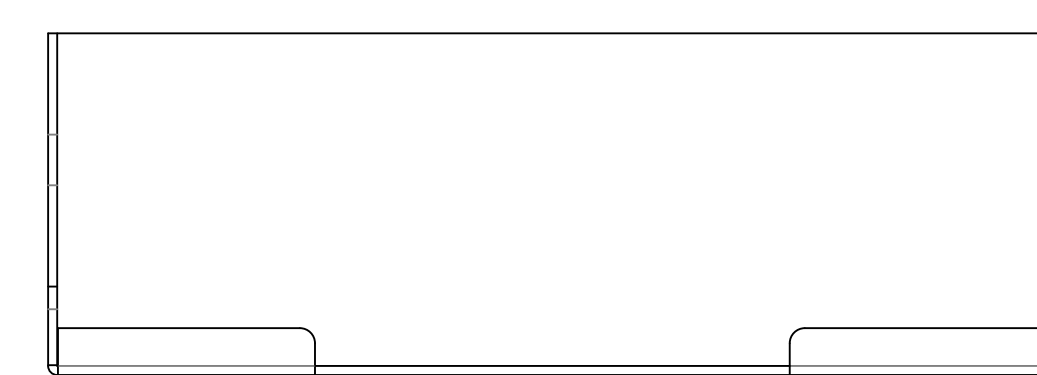

⑥ **BOTTOM VIEW**

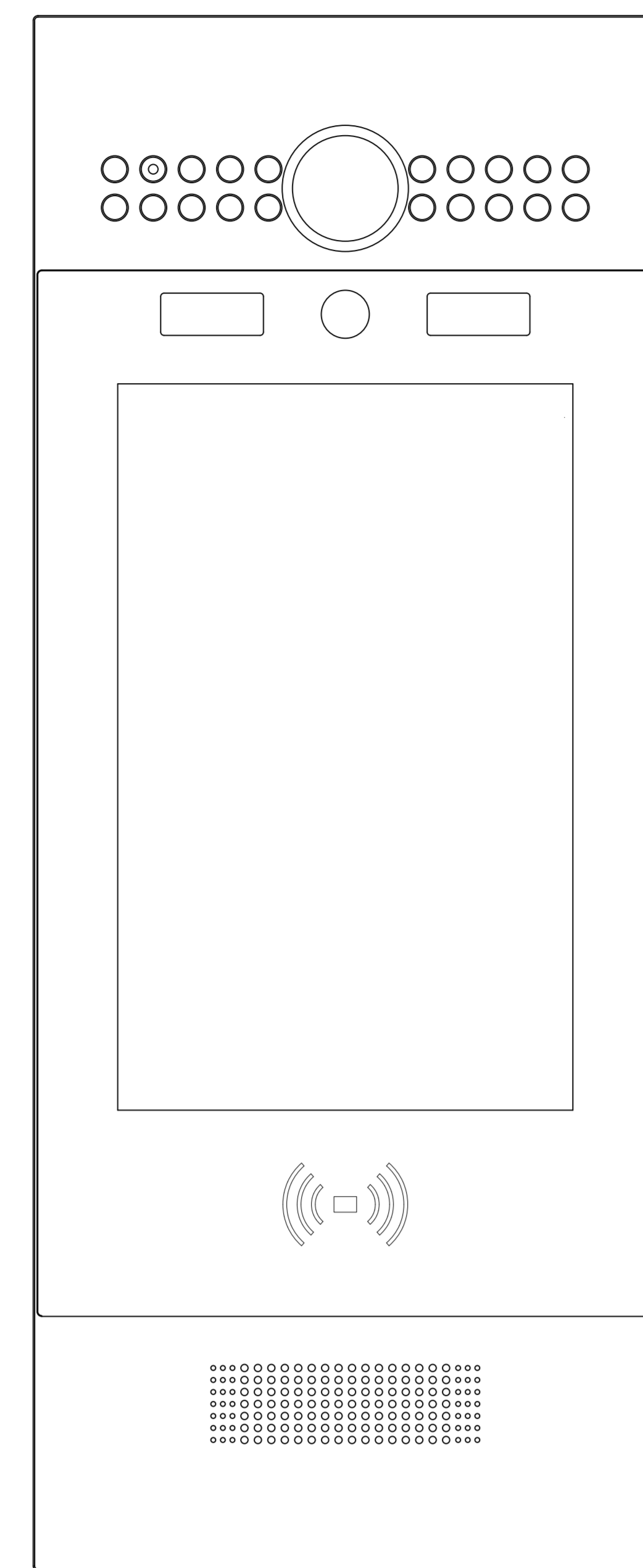

① INTERCOM PANEL FRONT VIEW

973mm TO BOTTOM OF PANEL

1220mm MAX TO TOP OF USABLE TOUCHSCREEN

ADA Compliance Requirement

GROUND

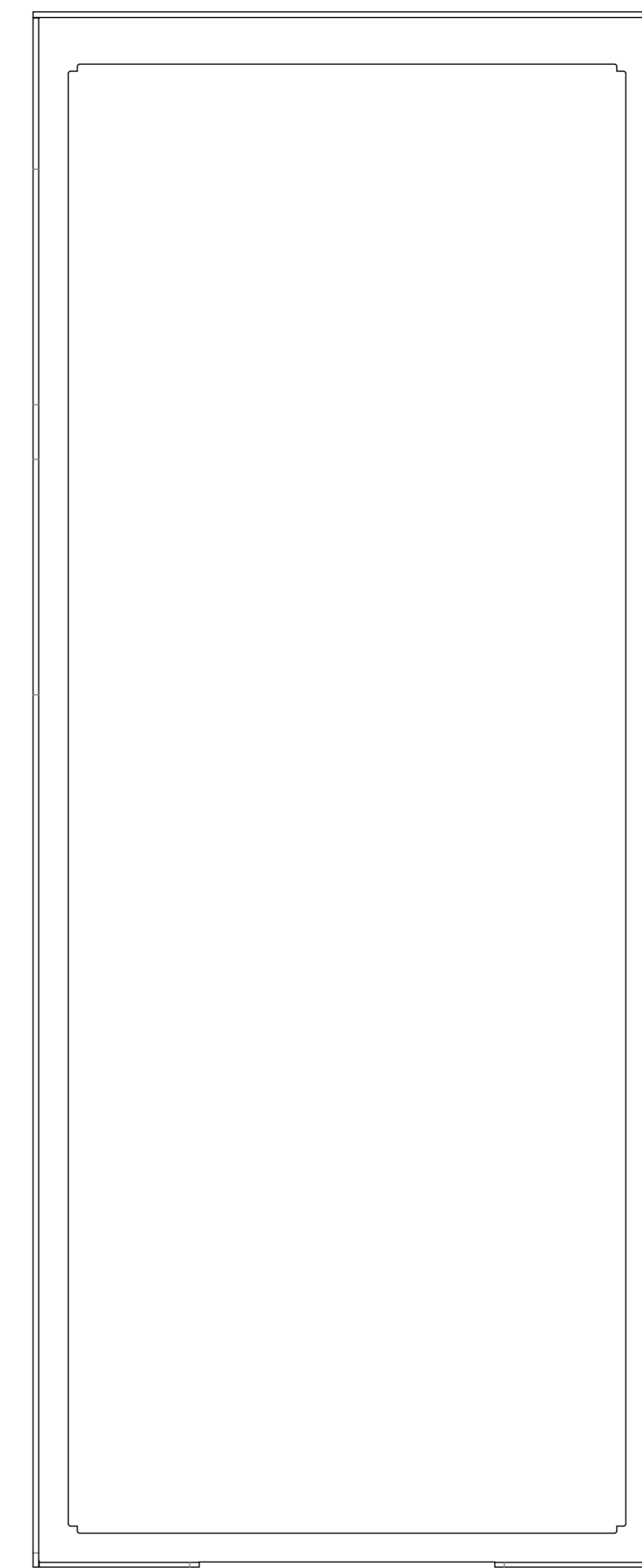

② FRONT VIEW: WALL MOUNTING RAIN COVER PLACEMENT

973 mm TO BOTTOM OF BRACKET

GROUND

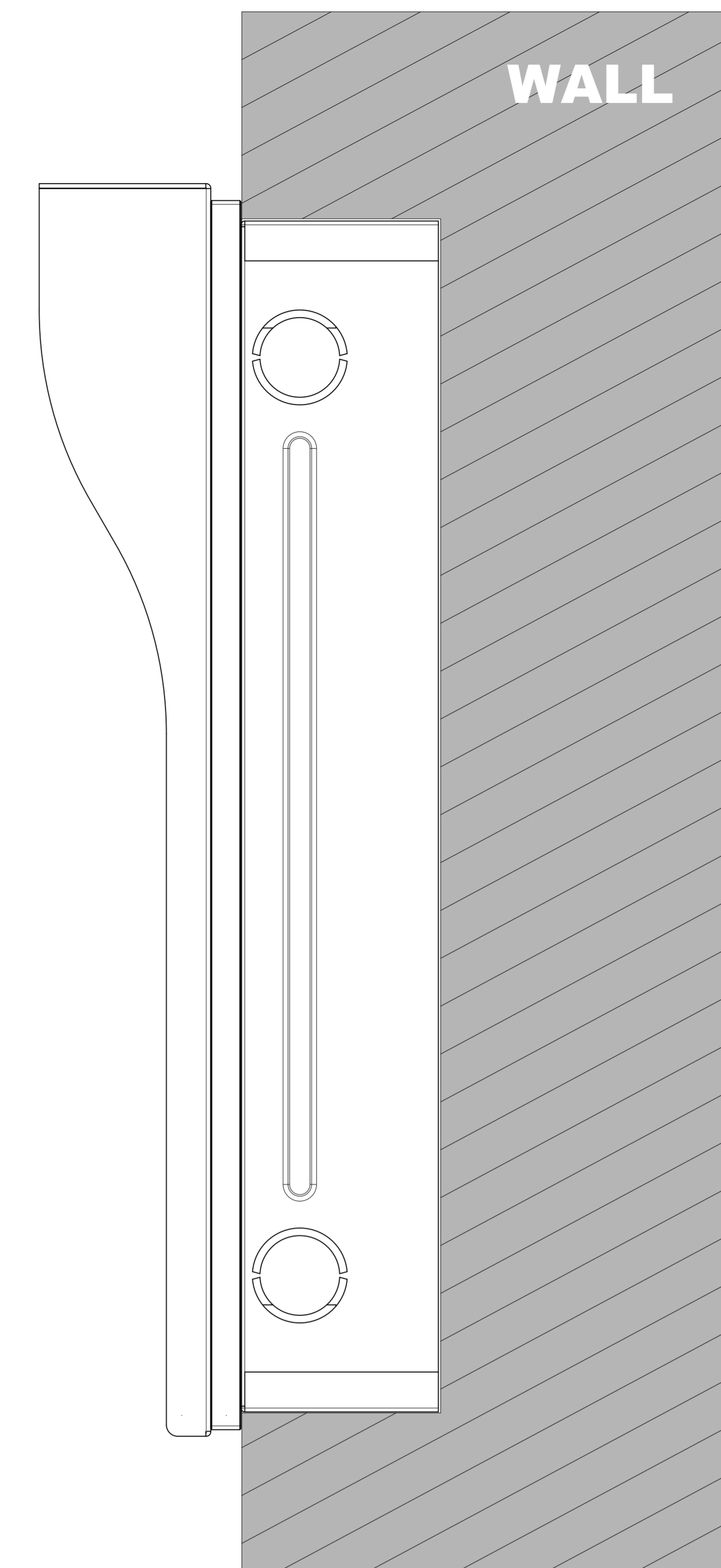

③ SIDE VIEW:INTERCOM IN WALL

WALL