

**Applicable Model**

C315

**Drawing Title**

Indoor Monitor Panel

**Drawing Unit**

mm

**Drawing Scale**

Not to scale

**DRAFT  
CHANGE TO  
SUBJECT**

**Last Revised**

May 05,2022

**Drawing Version**

V1.0

**Page**

1 of 3

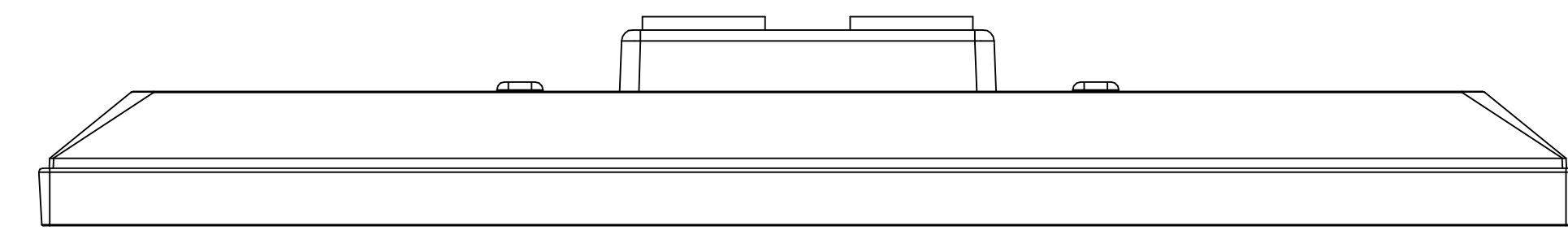

⑤ **TOP VIEW**

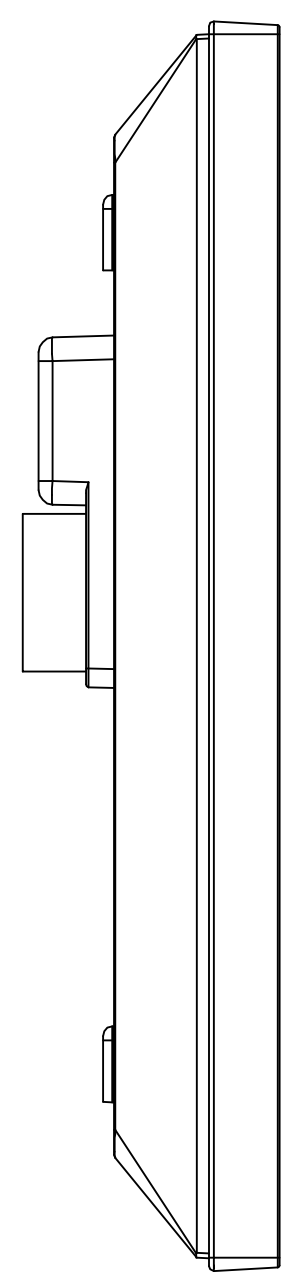

② **RIGHT VIEW**

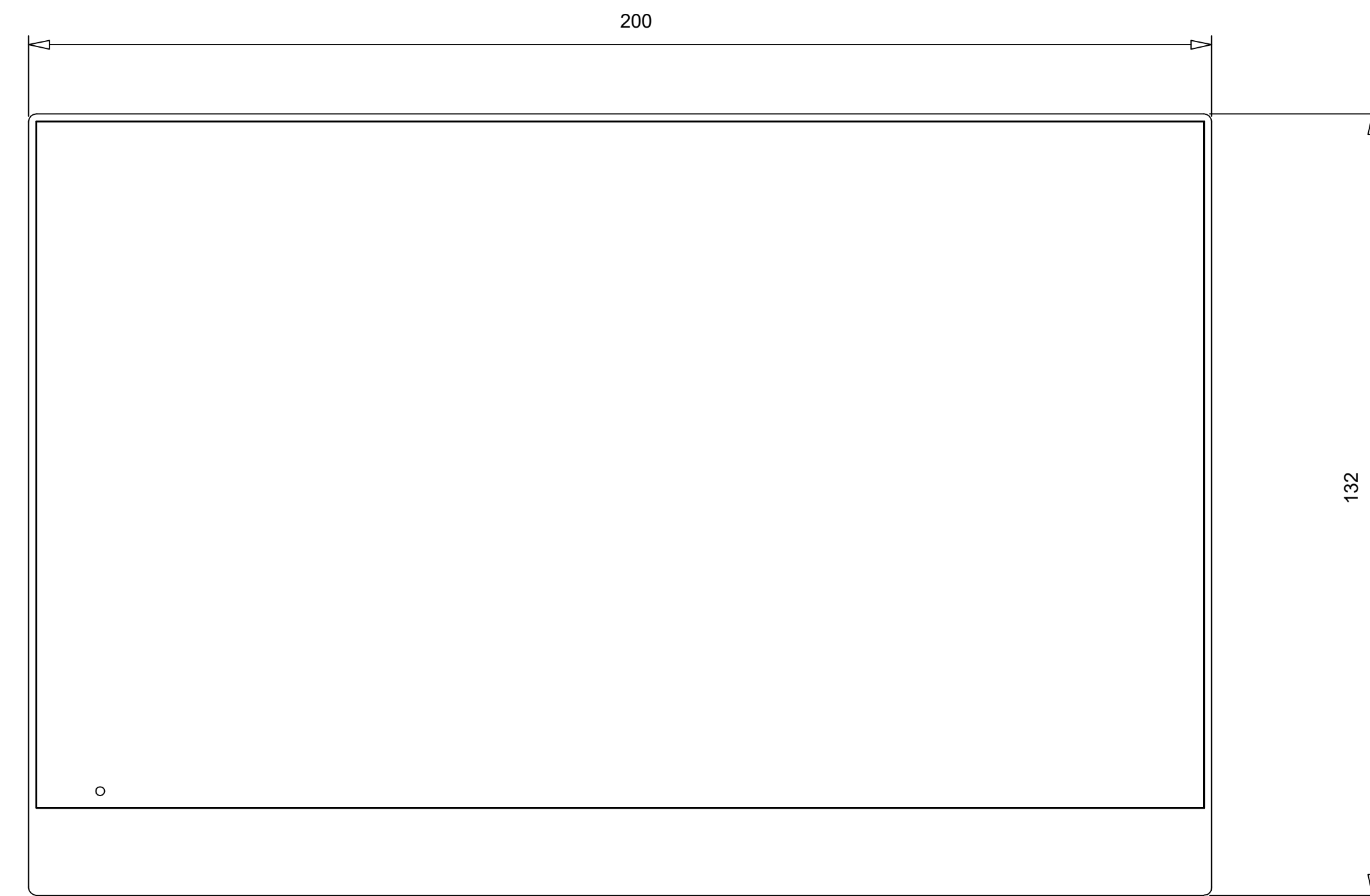

① **FRONT VIEW**

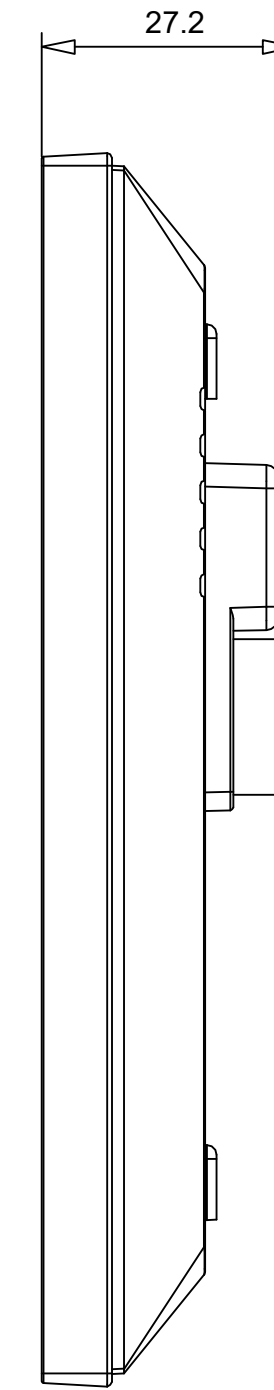

③ **LEFT VIEW**

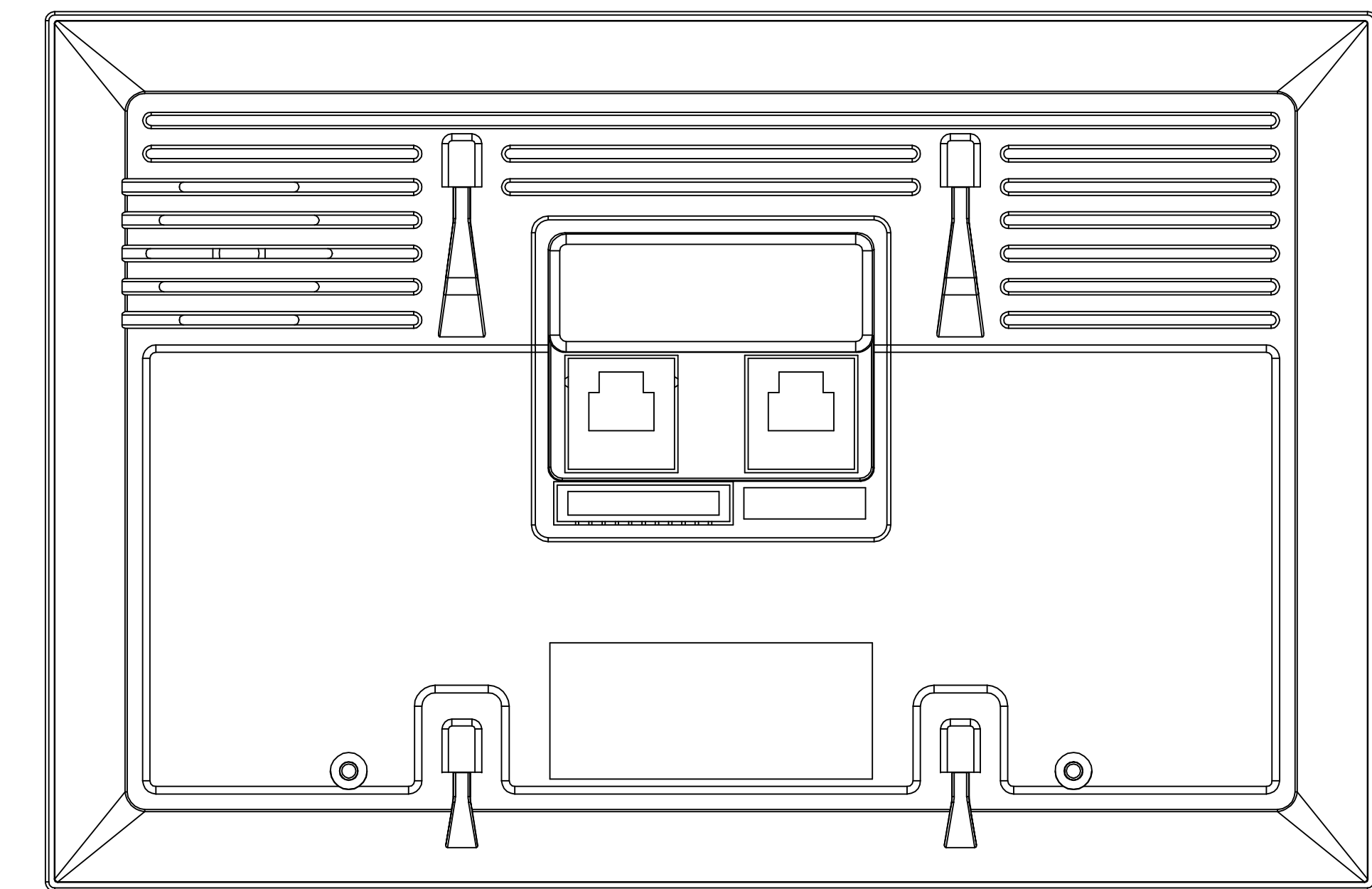

④ **BACK VIEW**

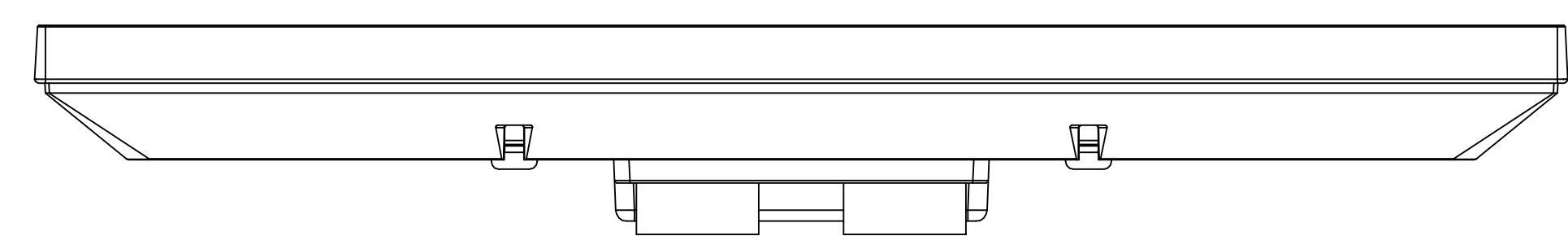

⑥ **BOTTOM VIEW**

**Applicable Model**

C315

**Drawing Title**

Wall Mounting Bracket

**Drawing Unit**

mm

**Drawing Scale**

Not to scale

**DRAFT  
SUBJECT TO  
CHANGE**

**Last Revised**

May 05,2022

**Drawing Version**

V1.0

**Page**

2 of 3



5 **TOP VIEW**

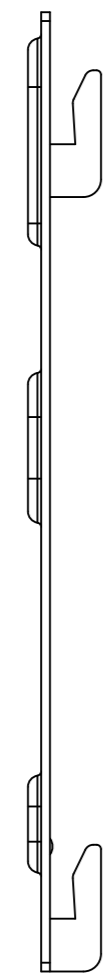

2 **RIGHT VIEW**

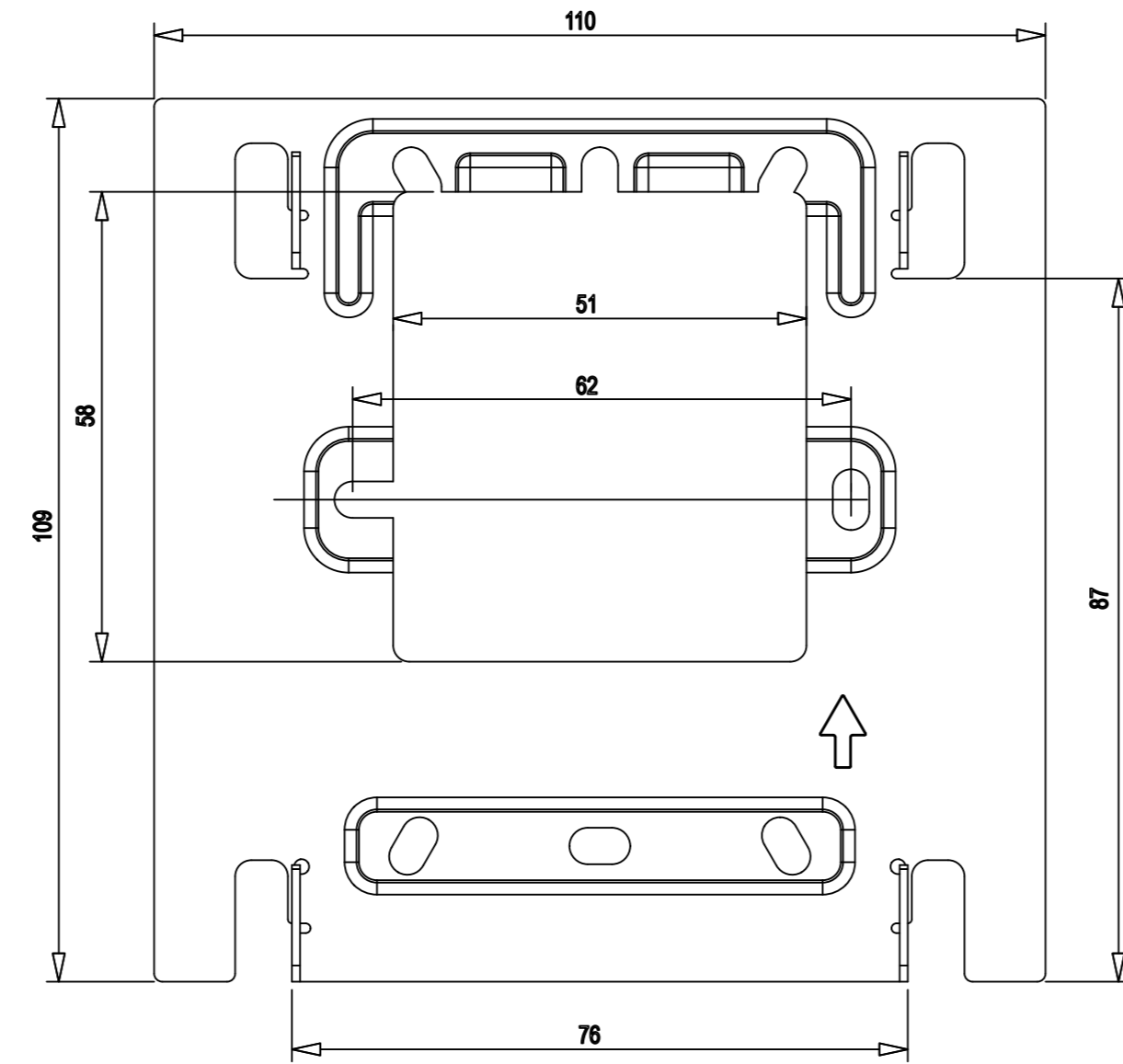

1 **FRONT VIEW**



3 **LEFT VIEW**

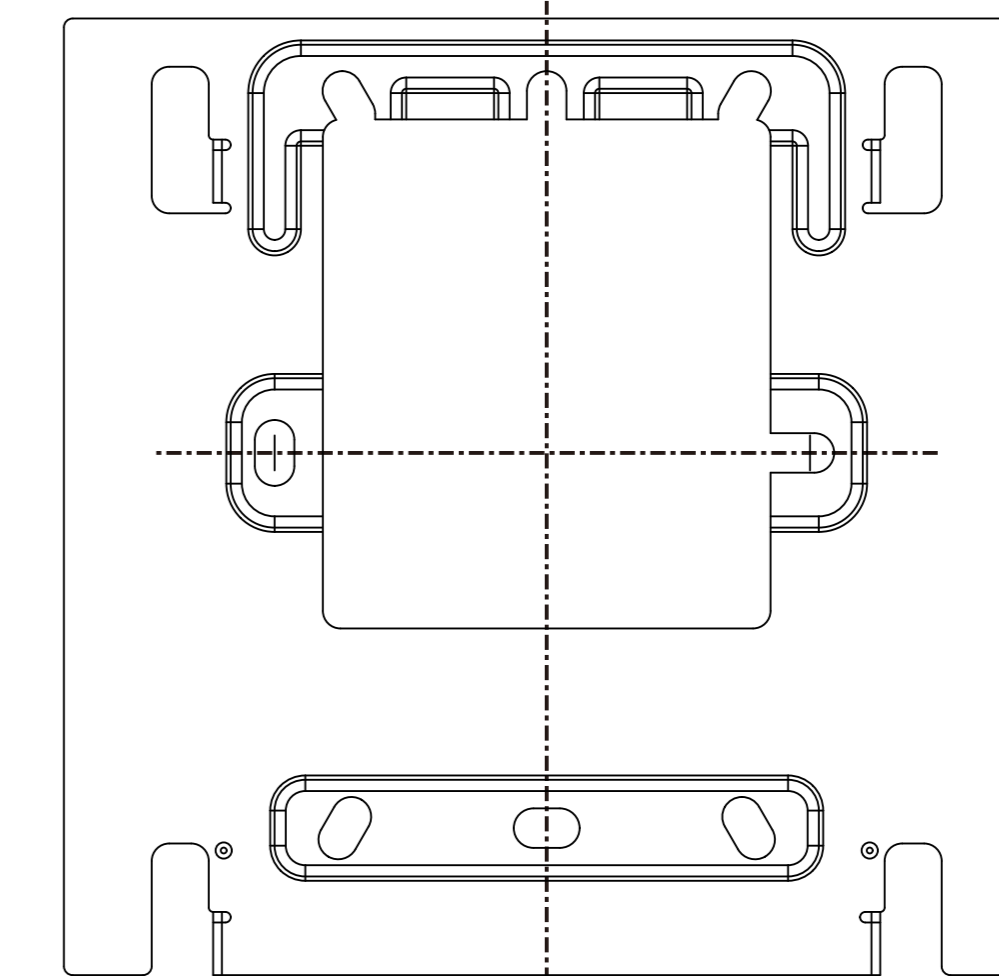

4 **BACK VIEW**



6 **BOTTOM VIEW**

**Applicable Model**

C315

**Drawing Title**

Placement

**Drawing Unit**

mm

**Drawing Scale**

Not to scale

**DRAFT  
SUBJECT TO  
CHANGE**

**Last Revised**

May 05,2022

**Drawing Version**

V1.0

**Page**

3 of 3

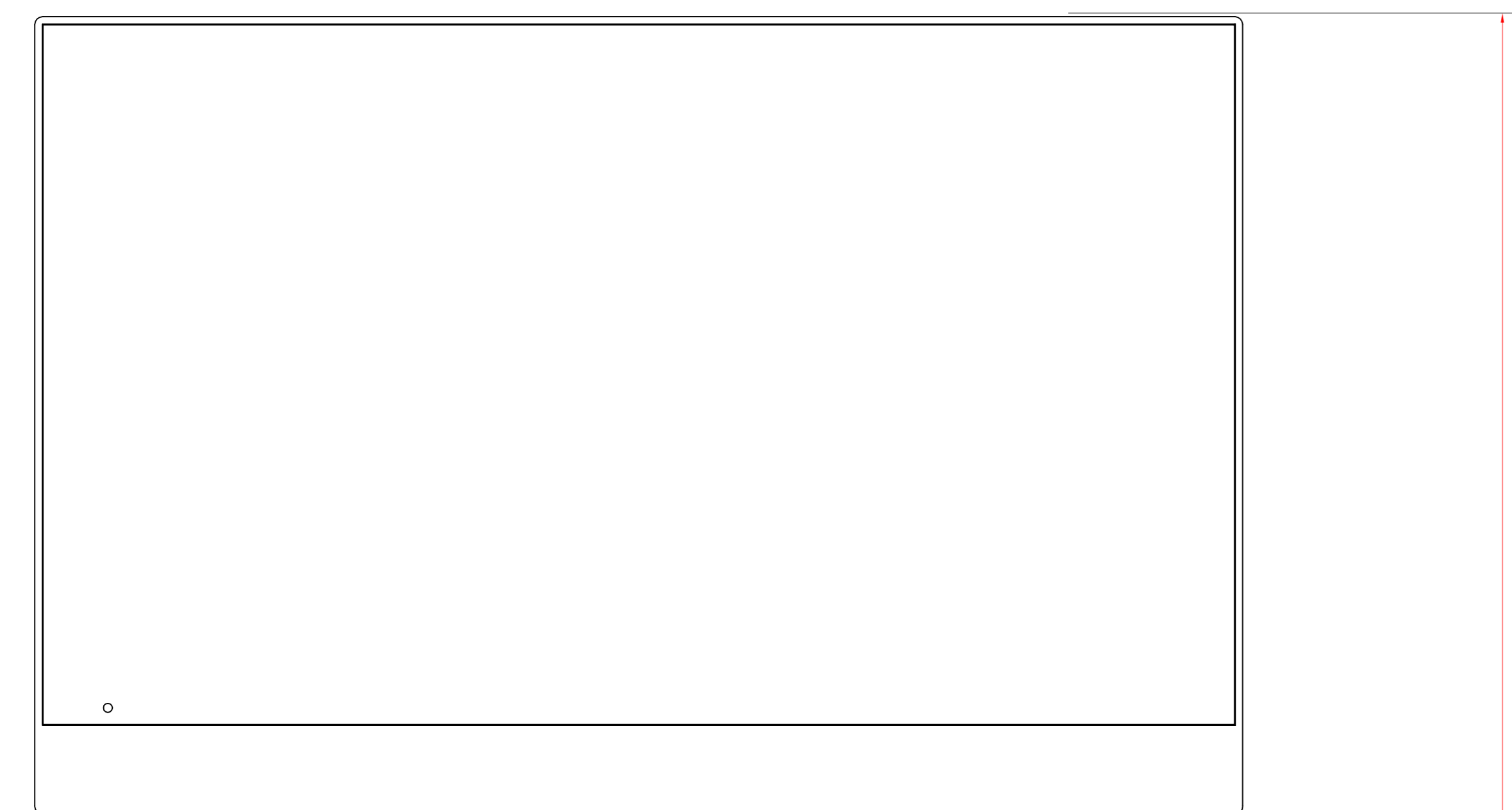

① INDOOR MONITOR PANEL FRONT VIEW

1070mm TO BOTTOM OF PANEL

1200mm MAX TO TOP OF USABLE TOUCHSCREEN

**ADA Compliance Requirement**

**GROUND**

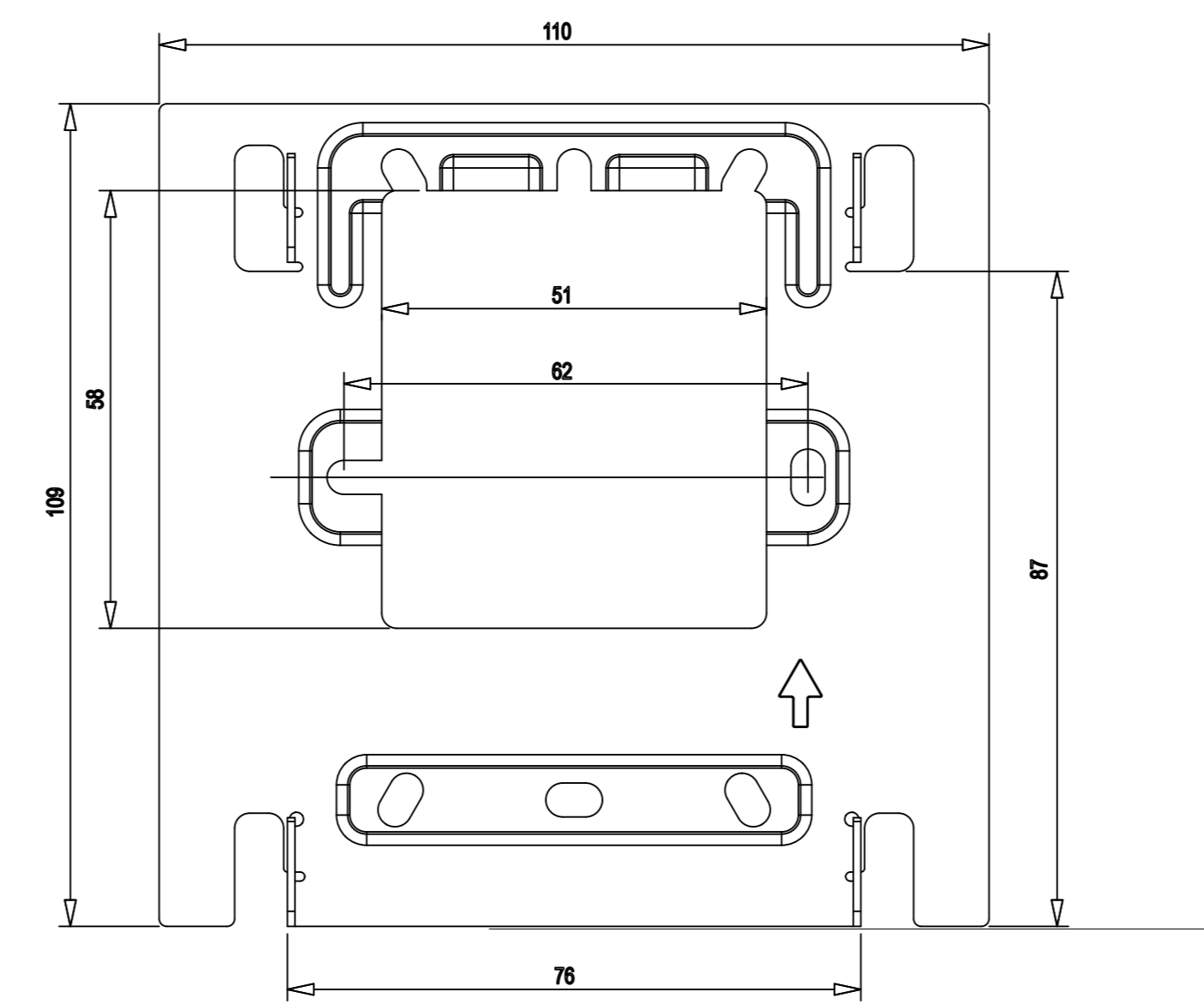

② FRONT VIEW:WALL MOUNTING BRACKET PLACEMENT

1070mm TO BOTTOM OF BRACKET

**GROUND**

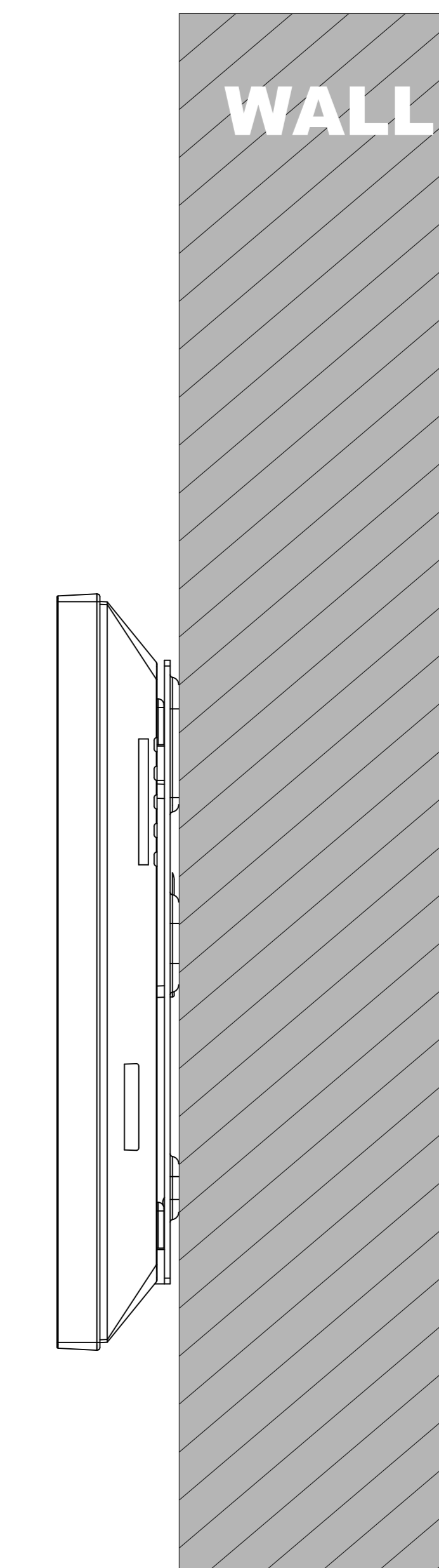

③ SIDE VIEW:INDOOR MONITOR ON WALL